

Powerful Circuit Protection

UL 489 and UL 1077 – AC/DC rated miniature circuit breakers



Introduction

Choose the right Weidmüller miniature circuit breaker (MCB)

(Always refer to the NEC before installing any device.)

When considering the UL 489 and UL 1077 Series MCBs, always assess the application for the following: voltage rating, maximum interrupting capacity, continuous current rating, frequency, and atypical operating conditions (ambient temperature, moisture, vibration, altitude, installation or operation orientation, and field maintenance). The MCBs are intended to protect the circuit cables as well as motors, generators and transformers, thyristors and silicon rectifiers. They also provide additional protection of computers and their peripheral equipment, industrial process control systems, telecommunications equipment and power supplies.

Ask the following:

- Is the application an AC or DC circuit?
Good news here, UL 489 and UL 1077 MCBs are rated for both AC and DC.
- Is a branch or supplemental breaker needed for the application?
Branch devices may be used in place of supplemental but not vice versa.
- How many poles are needed for each circuit being protected?
3p – 3 phase no neutral, 2p – L₁ and Neutral, 1p – L₁ only.
- Calculate and/or measure the normal current for the circuit and follow NEC guidelines. Match the breaker amps based on the normal current load. Weidmüller's MCB's run 1 to 63 amps (See Technical Data on page 4).
- Determine potential failure mode(s).
The MCB thermal magnetic devices are designed for interrupt short-circuit and overload events.
- What is the interrupt capacity (IC)?
Specify the breaker knowing the maximum fault current that can be repeatedly interrupted without failure of the breaker. UL 489 and UL 1077 MCBs have a maximum current at a given voltage that the breaker can interrupt safely without damage to surrounding components. (See Technical Data)
- What is the reaction time needed to a given fault condition?
Specify a breaker by selecting a speed that avoids nuisance tripping but protects against component damage (B, C or D curve)
- What are the functional requirements of the breaker?
The UL 489 and UL 1077 are rail mountable, easy to visually inspect, switch manually (or remotely trip with shunt trip devices) and monitor using an auxiliary contact. Mechanically 20,000 cycles and electrically 6,000 cycles.
- What is the wire size used?
Can the breaker accept the wire sizes required?
The UL 489 and UL 1077 are designed for $\leq 35\text{mm}^2$.
- What are the environmental factors:
ambient temperature, moisture, vibration?
Check to determine if there are unusual conditions in which the breaker must operate. The UL 489 and UL 1077 are specified to IP20, -35°C ... 70°C, and shock tested to IEC 60068-2-27.

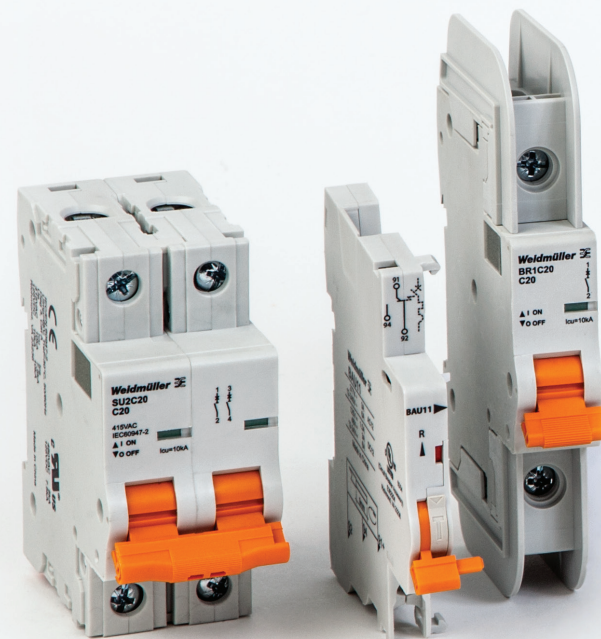

Applications

- Automotive Manufacturing
- Chemical, Oil and Gas
- Renewable Energy
- Rail Vehicles
- Automation
- Pharmaceutical and Food
- Steel Production
- Telecom and Datacom
- Power-D-Box-Systems
- Lighting Equipment
- Process Control



Pharmaceutical and Food



Chemical, Oil and Gas

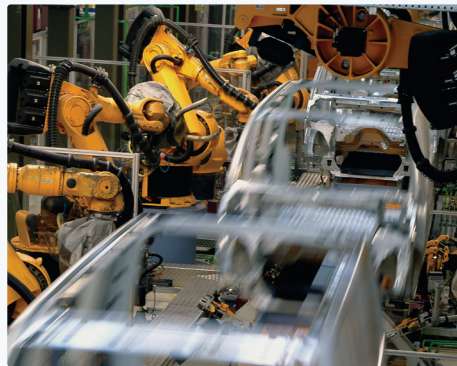

Automotive Manufacturing



Rail Vehicles



Application Schematic

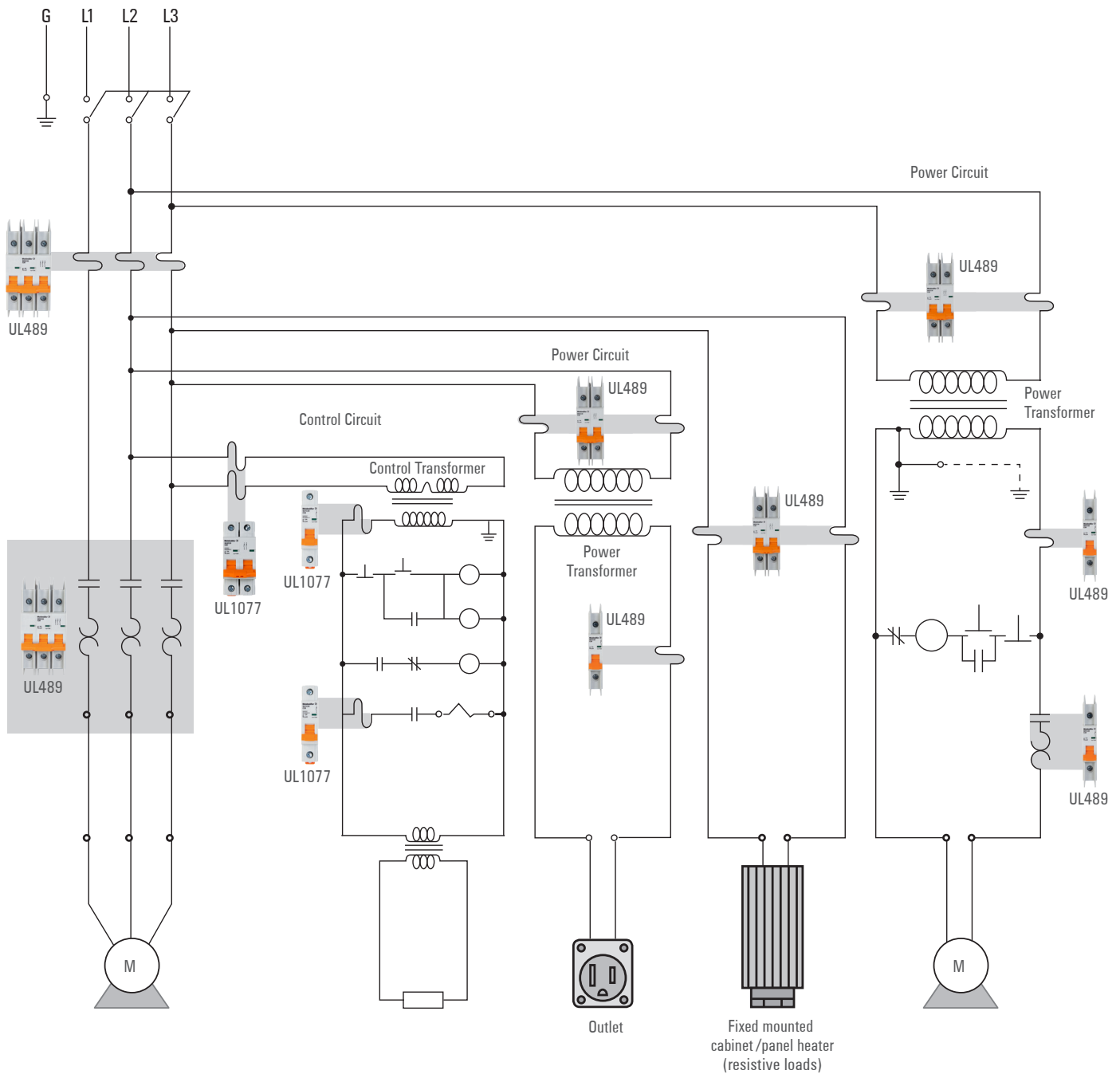

Sizing of main branch circuit protector according to table 430.52 in NEC®

- Dual Element (Time Delay) Fuse**
 Maximum fuse = largest motor FLA x 175%
 + FLA of all other motors and general loads in group
- Inverse Time Breaker**
 Maximum circuit breaker = largest motor FLA x 250%
 + FLA of all other motors and general loads in group
 (for other fuse/breaker types see table 430.52)

Thermal Magnetic Miniature Circuit Breakers

Description

1-, 2- and 3-pole thermal-magnetic miniature circuit breakers (MCBs) in accordance with EN 60947-2, UL 1077 and UL 489 for DIN-rail mounting, with toggle actuation, visual status indication and high rupture capacity. A positively trip-free snap action mechanism ensures reliable switching behavior. A range of trip characteristics and add-on modules allow a great variety of applications.

Typical Applications

- Protection of cables, motors, generators and transformers, thyristors and silicon rectifiers.
- Protection of computers and their peripheral equipment, industrial process control systems, telecommunications equipment, power supplies.



UL 489 version

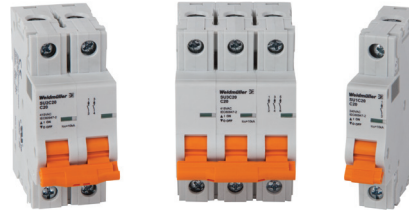

IEC/EN60947-2 & UL 1077 version

Technical Data

Voltage rating and current rating range					
to IEC/EN 60947-2		1-pole: AC 240 V; 1 A...63 A; 2 and 3-pole: AC 415 V, 1 A...63 A			
		1-pole: DC 80 V, 1 A...63 A			
		2-pole: (2 poles connected in series) DC 125 V, 1...63 A			
to UL 1077		1-pole: AC 277 V; 1 A...63 A; 2 and 3-pole: AC 480Y/277 V, 1 A...63 A			
		1-pole: DC 60 V; 1 A...63 A			
		2-pole (2 poles connected in series): DC 125 V; 1 A...63 A			
to UL 489		1-pole: AC 120 V; 1 A...63 A; 2 and 3-pole: AC 240 V, 1 A...63 A; 1-pole: AC 277 V; 1 A...32 A; 2 and 3-pole: AC 480Y/277 V; 1 A...32 A;			
		1-pole: DC 60 V; 1 A...63 A			
		2-pole (2 poles connected in series); DC 125 V; 1 A...63 A			
Typical life					
Mechanically		20,000 cycles			
Electrically		6,000 cycles			
Interrupt capacity					
to IEC/EN 60947-2 (Ics)		AC 7,500 A / DC 10,000 A			
to IEC/EN 60947-2 (Icu)		AC/DC 10,000 A			
to UL 489		AC/DC 10,000 A			
to UL1077					
Number of poles	Un	In	TC	OL	SC
1-pole	AC 240 V	1...63 A	1	1	7.5 kA, U1
1-pole	AC 277 V	1...63 A	1	0	5 kA, U1
2-, 3-pole	AC 480 V	1...63 A	1	1	5 kA, U1
1-pole	DC 60 V	1...63 A	1	0	7.5 kA, U1
2-pole in series	DC 125 V	1...63 A	1	0	7.5 kA, U1
Insulation coordination		6 kV/3 (reinforced insulation at operating area)			

Degree of protection	IP20
Vibration (sinusoidal) test to IEC 60068-2-6, test Fc	± 0.38 mm (10–57 Hz), 5 g (57–500 Hz) 10 frequency cycles per axis
Shock, test to IEC 60068-2-27, test Ea	30 g (11 ms)
Corrosion, test to IEC 60068-2-11, test Ka	96 hrs in 5% salt mist
Humidity, test to IEC 60068-2-78, test Cab	48 hours at 95% RH, temperature +40°C
Terminals	screw terminals; Vertical connection possible by means of busbars
Tightening torque	2 Nm max.
Cable cross section	≤35 mm ²
Ambient temperature	-35°C...+70°C
Mounting	rail mounting
Mass	approx. 116 g per pole (EN 60947-2/ UL 1077) approx. 131 g per pole (UL 489)

Approvals

Approval authority	Standard	Rated voltage	Current ratings
TÜV	IEC/EN 60947-2	AC 240/415 V	1...63 A
		DC 80 V	1...63 A (1-pole)
		DC 125 V	1...63 A (2 poles in series)
UL	UL 1077 / CSA-C22.2 No. 235	AC 480Y/277 V	1...63 A
		DC 60 V	1...63 A (1-pole)
		DC 125 V	1...63 A (2 poles in series)
UL	UL 489 / CSA-C22.2 No. 5	AC 240 V	1...63 A
		AC 480Y/277 V	1...32 A
		DC 60 V	1...63 A (1-pole)
		DC 125 V	1...63 A (2 poles in series)

* Note: Breakers are line and load reversible

For information on Weidmüller's UL Certifications, visit the UL Online Certifications Directory and search by the UL file numbers E359481, E362204 and E359964.



UL 489 DIN-Rail Branch Rated Circuit Breakers

MCB 489 Product Selection Order No. Nomenclature

(Order No. found on the front of the breaker)

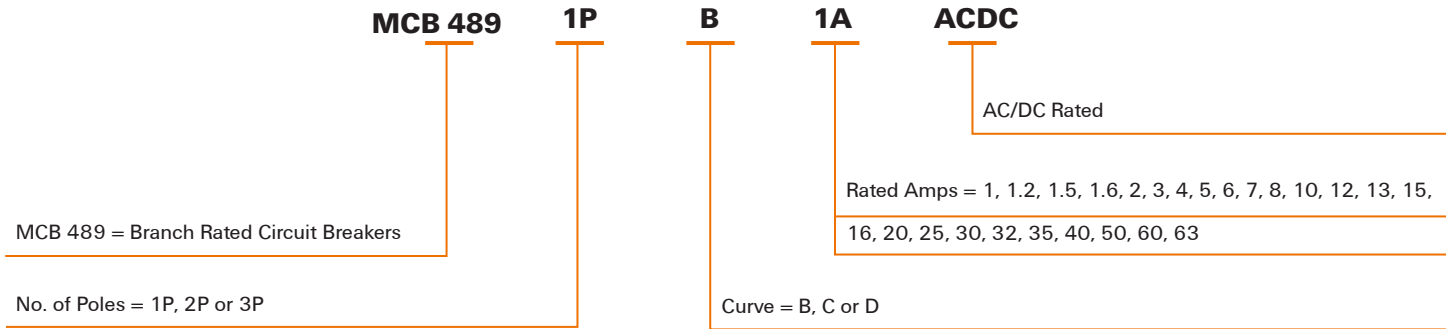

Schematic Diagrams

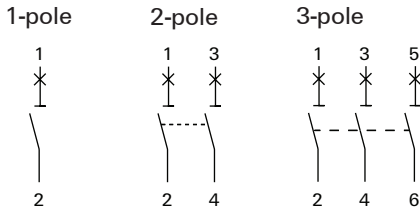

DC Application

When using the circuit breakers in DC applications, polarity does not have to be observed. Maximum acceptable voltage between the conductors depends on the number of poles, circuitry and relevant standard / approval.

To UL 489:

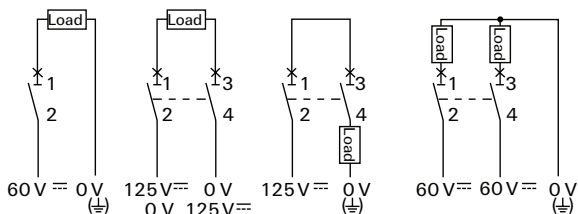

Dimensions - UL 489 version

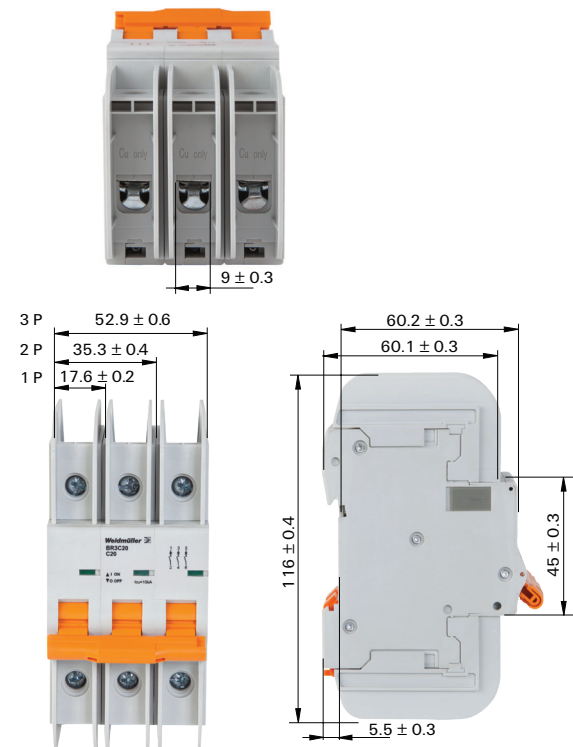

All dimensions without tolerances are for reference only. Weidmüller reserves the right to change specifications at any time without notice in the interest of improved design, performance and cost effectiveness.

MCB 489 Series Product Selection

B Curve – UL 489 DIN-Rail Branch Circuit Breakers

(See Curve Drawings on page 13 and 14)

Amps Rating	1 Pole		2 Pole		3 Pole	
	Order No.	Description	Order No.	Description	Order No.	Description
1	2477040000	MCB 489 1P B 1A ACDC	2477290000	MCB 489 2P B 1A ACDC	2477540000	MCB 489 3P B 1A ACDC
1.2	2477050000	MCB 489 1P B 1.2A ACDC	2477300000	MCB 489 2P B 1.2A ACDC	2477550000	MCB 489 3P B 1.2A ACDC
1.5	2477060000	MCB 489 1P B 1.5A ACDC	2477310000	MCB 489 2P B 1.5A ACDC	2477560000	MCB 489 3P B 1.5A ACDC
1.6	2477070000	MCB 489 1P B 1.6A ACDC	2477320000	MCB 489 2P B 1.6A ACDC	2477570000	MCB 489 3P B 1.6A ACDC
2	2477090000	MCB 489 1P B 2A ACDC	2477330000	MCB 489 2P B 2A ACDC	2477580000	MCB 489 3P B 2A ACDC
3	2477080000	MCB 489 1P B 3A ACDC	2477340000	MCB 489 2P B 3A ACDC	2477590000	MCB 489 3P B 3A ACDC
4	2477100000	MCB 489 1P B 4A ACDC	2477350000	MCB 489 2P B 4A ACDC	2477600000	MCB 489 3P B 4A ACDC
5	2477110000	MCB 489 1P B 5A ACDC	2477360000	MCB 489 2P B 5A ACDC	2477610000	MCB 489 3P B 5A ACDC
6	2477120000	MCB 489 1P B 6A ACDC	2477370000	MCB 489 2P B 6A ACDC	2477620000	MCB 489 3P B 6A ACDC
7	2477130000	MCB 489 1P B 7A ACDC	2477380000	MCB 489 2P B 7A ACDC	2477630000	MCB 489 3P B 7A ACDC
8	2477140000	MCB 489 1P B 8A ACDC	2477390000	MCB 489 2P B 8A ACDC	2477640000	MCB 489 3P B 8A ACDC
10	2515480000	MCB 489 1P B 10A ACDC	2477400000	MCB 489 2P B 10A ACDC	2477650000	MCB 489 3P B 10A ACDC
12	2477160000	MCB 489 1P B 12A ACDC	2477410000	MCB 489 2P B 12A ACDC	2477660000	MCB 489 3P B 12A ACDC
13	2477170000	MCB 489 1P B 13A ACDC	2477420000	MCB 489 2P B 13A ACDC	2477670000	MCB 489 3P B 13A ACDC
15	2477180000	MCB 489 1P B 15A ACDC	2477430000	MCB 489 2P B 15A ACDC	2477680000	MCB 489 3P B 15A ACDC
16	2477190000	MCB 489 1P B 16A ACDC	2477440000	MCB 489 2P B 16A ACDC	2477690000	MCB 489 3P B 16A ACDC
20	2477200000	MCB 489 1P B 20A ACDC	2477450000	MCB 489 2P B 20A ACDC	2477700000	MCB 489 3P B 20A ACDC
25	2477210000	MCB 489 1P B 25A ACDC	2477460000	MCB 489 2P B 25A ACDC	2477710000	MCB 489 3P B 25A ACDC
30	2477220000	MCB 489 1P B 30A ACDC	2477470000	MCB 489 2P B 30A ACDC	2477720000	MCB 489 3P B 30A ACDC
32	2477230000	MCB 489 1P B 32A ACDC	2477480000	MCB 489 2P B 32A ACDC	2477730000	MCB 489 3P B 32A ACDC
35	2477240000	MCB 489 1P B 35A ACDC	2477490000	MCB 489 2P B 35A ACDC	2477740000	MCB 489 3P B 35A ACDC
40	2477250000	MCB 489 1P B 40A ACDC	2477500000	MCB 489 2P B 40A ACDC	2477750000	MCB 489 3P B 40A ACDC
50	2477260000	MCB 489 1P B 50A ACDC	2477510000	MCB 489 2P B 50A ACDC	2477760000	MCB 489 3P B 50A ACDC
60	2477270000	MCB 489 1P B 60A ACDC	2477520000	MCB 489 2P B 60A ACDC	2477770000	MCB 489 3P B 60A ACDC
63	2477280000	MCB 489 1P B 63A ACDC	2477530000	MCB 489 2P B 63A ACDC	2477780000	MCB 489 3P B 63A ACDC

MCB 489 Series Product Selection

C Curve – UL 489 DIN-Rail Branch Circuit Breakers

(See Curve Drawings on page 13 and 14)

Amps Rating	1 Pole		2 Pole		3 Pole	
	Order No.	Description	Order No.	Description	Order No.	Description
1	2477790000	MCB 489 1P C 1A ACDC	2478040000	MCB 489 2P C 1A ACDC	2478290000	MCB 489 3P C 1A ACDC
1.2	2477800000	MCB 489 1P C 1.2A ACDC	2478050000	MCB 489 2P C 1.2A ACDC	2478300000	MCB 489 3P C 1.2A ACDC
1.5	2477810000	MCB 489 1P C 1.5A ACDC	2478060000	MCB 489 2P C 1.5A ACDC	2478310000	MCB 489 3P C 1.5A ACDC
1.6	2477820000	MCB 489 1P C 1.6A ACDC	2478070000	MCB 489 2P C 1.6A ACDC	2478320000	MCB 489 3P C 1.6A ACDC
2	2477830000	MCB 489 1P C 2A ACDC	2478080000	MCB 489 2P C 2A ACDC	2478330000	MCB 489 3P C 2A ACDC
3	2477840000	MCB 489 1P C 3A ACDC	2478090000	MCB 489 2P C 3A ACDC	2478340000	MCB 489 3P C 3A ACDC
4	2477850000	MCB 489 1P C 4A ACDC	2478100000	MCB 489 2P C 4A ACDC	2478350000	MCB 489 3P C 4A ACDC
5	2477860000	MCB 489 1P C 5A ACDC	2478110000	MCB 489 2P C 5A ACDC	2478360000	MCB 489 3P C 5A ACDC
6	2477870000	MCB 489 1P C 6A ACDC	2478120000	MCB 489 2P C 6A ACDC	2478370000	MCB 489 3P C 6A ACDC
7	2477880000	MCB 489 1P C 7A ACDC	2478130000	MCB 489 2P C 7A ACDC	2478380000	MCB 489 3P C 7A ACDC
8	2477890000	MCB 489 1P C 8A ACDC	2478140000	MCB 489 2P C 8A ACDC	2478390000	MCB 489 3P C 8A ACDC
10	2477900000	MCB 489 1P C 10A ACDC	2478150000	MCB 489 2P C 10A ACDC	2478400000	MCB 489 3P C 10A ACDC
12	2477910000	MCB 489 1P C 12A ACDC	2478160000	MCB 489 2P C 12A ACDC	2478410000	MCB 489 3P C 12A ACDC
13	2477920000	MCB 489 1P C 13A ACDC	2478170000	MCB 489 2P C 13A ACDC	2478420000	MCB 489 3P C 13A ACDC
15	2477930000	MCB 489 1P C 15A ACDC	2478180000	MCB 489 2P C 15A ACDC	2478430000	MCB 489 3P C 15A ACDC
16	2477940000	MCB 489 1P C 16A ACDC	2478190000	MCB 489 2P C 16A ACDC	2478440000	MCB 489 3P C 16A ACDC
20	2477950000	MCB 489 1P C 20A ACDC	2478200000	MCB 489 2P C 20A ACDC	2478450000	MCB 489 3P C 20A ACDC
25	2477960000	MCB 489 1P C 25A ACDC	2478210000	MCB 489 2P C 25A ACDC	2478460000	MCB 489 3P C 25A ACDC
30	2477970000	MCB 489 1P C 30A ACDC	2478220000	MCB 489 2P C 30A ACDC	2478470000	MCB 489 3P C 30A ACDC
32	2477980000	MCB 489 1P C 32A ACDC	2478230000	MCB 489 2P C 32A ACDC	2478480000	MCB 489 3P C 32A ACDC
35	2477990000	MCB 489 1P C 35A ACDC	2478240000	MCB 489 2P C 35A ACDC	2478490000	MCB 489 3P C 35A ACDC
40	2478000000	MCB 489 1P C 40A ACDC	2478250000	MCB 489 2P C 40A ACDC	2478500000	MCB 489 3P C 40A ACDC
50	2478010000	MCB 489 1P C 50A ACDC	2478260000	MCB 489 2P C 50A ACDC	2478510000	MCB 489 3P C 50A ACDC
60	2478020000	MCB 489 1P C 60A ACDC	2478270000	MCB 489 2P C 60A ACDC	2478520000	MCB 489 3P C 60A ACDC
63	2478030000	MCB 489 1P C 63A ACDC	2478280000	MCB 489 2P C 63A ACDC	2478530000	MCB 489 3P C 63A ACDC

MCB 489 Series Product Selection

D Curve – UL 489 DIN-Rail Branch Circuit Breakers

(See Curve Drawings on page 13 and 14)

Amps Rating	1 Pole		2 Pole		3 Pole	
	Order No.	Description	Order No.	Description	Order No.	Description
1	2478540000	MCB 489 1P D 1A ACDC	2478790000	MCB 489 2P D 1A ACDC	2479030000	MCB 489 3P D 1A ACDC
1.2	2478550000	MCB 489 1P D 1.2A ACDC	2478800000	MCB 489 2P D 1.2A ACDC	2479040000	MCB 489 3P D 1.2A ACDC
1.5	2478560000	MCB 489 1P D 1.5A ACDC	2478810000	MCB 489 2P D 1.5A ACDC	2479050000	MCB 489 3P D 1.5A ACDC
1.6	2478570000	MCB 489 1P D 1.6A ACDC	2478820000	MCB 489 2P D 1.6A ACDC	2479060000	MCB 489 3P D 1.6A ACDC
2	2478580000	MCB 489 1P D 2A ACDC	2478830000	MCB 489 2P D 2A ACDC	2479070000	MCB 489 3P D 2A ACDC
3	2478590000	MCB 489 1P D 3A ACDC	2478840000	MCB 489 2P D 3A ACDC	2479080000	MCB 489 3P D 3A ACDC
4	2478600000	MCB 489 1P D 4A ACDC	2478850000	MCB 489 2P D 4A ACDC	2479090000	MCB 489 3P D 4A ACDC
5	2515520000	MCB 489 1P D 5A ACDC	2478860000	MCB 489 2P D 5A ACDC	2479100000	MCB 489 3P D 5A ACDC
6	2478620000	MCB 489 1P D 6A ACDC	2478870000	MCB 489 2P D 6A ACDC	2479110000	MCB 489 3P D 6A ACDC
7	2478630000	MCB 489 1P D 7A ACDC	2515530000	MCB 489 2P D 7A ACDC	2479120000	MCB 489 3P D 7A ACDC
8	2478640000	MCB 489 1P D 8A ACDC	2478880000	MCB 489 2P D 8A ACDC	2479130000	MCB 489 3P D 8A ACDC
10	2478650000	MCB 489 1P D 10A ACDC	2478890000	MCB 489 2P D 10A ACDC	2479140000	MCB 489 3P D 10A ACDC
12	2478660000	MCB 489 1P D 12A ACDC	2478900000	MCB 489 2P D 12A ACDC	2479150000	MCB 489 3P D 12A ACDC
13	2478670000	MCB 489 1P D 13A ACDC	2478910000	MCB 489 2P D 13A ACDC	2479160000	MCB 489 3P D 13A ACDC
15	2478680000	MCB 489 1P D 15A ACDC	2478920000	MCB 489 2P D 15A ACDC	2479170000	MCB 489 3P D 15A ACDC
16	2478690000	MCB 489 1P D 16A ACDC	2478930000	MCB 489 2P D 16A ACDC	2479180000	MCB 489 3P D 16A ACDC
20	2478700000	MCB 489 1P D 20A ACDC	2478940000	MCB 489 2P D 20A ACDC	2479190000	MCB 489 3P D 20A ACDC
25	2478710000	MCB 489 1P D 25A ACDC	2478950000	MCB 489 2P D 25A ACDC	2479200000	MCB 489 3P D 25A ACDC
30	2478720000	MCB 489 1P D 30A ACDC	2478960000	MCB 489 2P D 30A ACDC	2479210000	MCB 489 3P D 30A ACDC
32	2478730000	MCB 489 1P D 32A ACDC	2478970000	MCB 489 2P D 32A ACDC	2479220000	MCB 489 3P D 32A ACDC
35	2478740000	MCB 489 1P D 35A ACDC	2478980000	MCB 489 2P D 35A ACDC	2479230000	MCB 489 3P D 35A ACDC
40	2478750000	MCB 489 1P D 40A ACDC	2478990000	MCB 489 2P D 40A ACDC	2479240000	MCB 489 3P D 40A ACDC
50	2478760000	MCB 489 1P D 50A ACDC	2479000000	MCB 489 2P D 50A ACDC	2479250000	MCB 489 3P D 50A ACDC
60	2478770000	MCB 489 1P D 60A ACDC	2479010000	MCB 489 2P D 60A ACDC	2479260000	MCB 489 3P D 60A ACDC
63	2478780000	MCB 489 1P D 63A ACDC	2479020000	MCB 489 2P D 63A ACDC	2515540000	MCB 489 3P D 63A ACDC

UL 1077 DIN-Rail Supplementary Circuit Breakers

MCB 1077 Product Selection Order No. Nomenclature

(Order No. found on the front of the breaker)



MCB1077	2P	D	60A	ACDC
MCB 1077 = Supplementary Protectors No. of Poles = 1P, 2P or 3P		AC/DC Rated Rated Amps = 1, 1.2, 1.5, 1.6, 2, 3, 4, 5, 6, 7, 8, 10, 12, 13, 15, 16, 20, 25, 30, 32, 35, 40, 50, 60, 63 Curve = B, C or D		

Schematic Diagrams

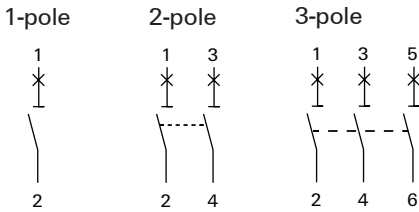

DC Application

When using the circuit breakers in DC applications, polarity does not have to be observed. Maximum acceptable voltage between the conductors depends on the number of poles, circuitry and relevant standard / approval.

To IEC/EN 60947-2:

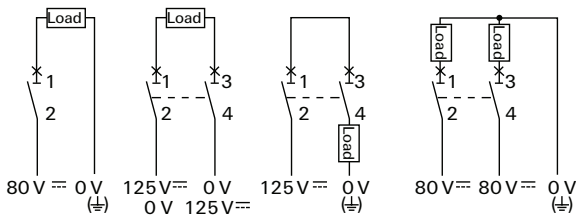

To UL 1077:

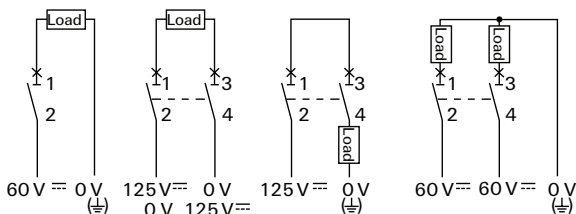

Dimensions – IEC/EN 60947-2 / UL1077 version

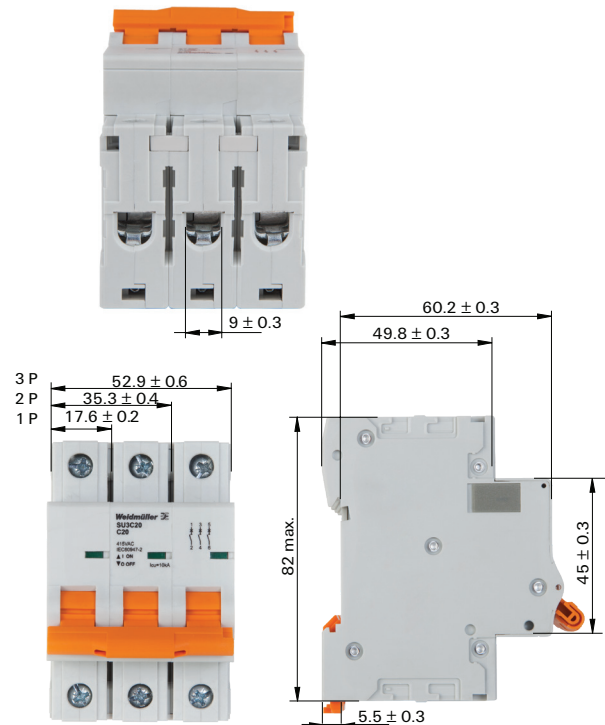

All dimensions without tolerances are for reference only. Weidmüller reserves the right to change specifications at any time without notice in the interest of improved design, performance and cost effectiveness.

MCB 1077 Product Selection

B Curve - UL 1077 DIN-Rail Supplementary Circuit Breakers

(See Curve Drawings on page 13 and 14)

Amps Rating	1 Pole		2 Pole		3 Pole	
	Order No.	Description	Order No.	Description	Order No.	Description
1	2479280000	MCB 1077 1P B 1A ACDC	2479520000	MCB 1077 2P B 1A ACDC	2479760000	MCB 1077 3P B 1A ACDC
1.2	2479290000	MCB 1077 1P B 1.2A ACDC	2479530000	MCB 1077 2P B 1.2A ACDC	2479770000	MCB 1077 3P B 1.2A ACDC
1.5	2479300000	MCB 1077 1P B 1.5A ACDC	2479540000	MCB 1077 2P B 1.5A ACDC	2479780000	MCB 1077 3P B 1.5A ACDC
1.6	2479310000	MCB 1077 1P B 1.6A ACDC	2521330000	MCB 1077 2P B 1.6A ACDC	2479790000	MCB 1077 3P B 1.6A ACDC
2	2479320000	MCB 1077 1P B 2A ACDC	2479560000	MCB 1077 2P B 2A ACDC	2479800000	MCB 1077 3P B 2A ACDC
3	2479330000	MCB 1077 1P B 3A ACDC	2479570000	MCB 1077 2P B 3A ACDC	2479810000	MCB 1077 3P B 3A ACDC
4	2479340000	MCB 1077 1P B 4A ACDC	2479580000	MCB 1077 2P B 4A ACDC	2479820000	MCB 1077 3P B 4A ACDC
5	2479350000	MCB 1077 1P B 5A ACDC	2479590000	MCB 1077 2P B 5A ACDC	2479830000	MCB 1077 3P B 5A ACDC
6	2479360000	MCB 1077 1P B 6A ACDC	2479600000	MCB 1077 2P B 6A ACDC	2479840000	MCB 1077 3P B 6A ACDC
7	2479370000	MCB 1077 1P B 7A ACDC	2479610000	MCB 1077 2P B 7A ACDC	2479850000	MCB 1077 3P B 7A ACDC
8	2479380000	MCB 1077 1P B 8A ACDC	2479620000	MCB 1077 2P B 8A ACDC	2479860000	MCB 1077 3P B 8A ACDC
10	2515110000	MCB 1077 1P B 10A ACDC	2479630000	MCB 1077 2P B 10A ACDC	2479870000	MCB 1077 3P B 10A ACDC
12	2479400000	MCB 1077 1P B 12A ACDC	2479640000	MCB 1077 2P B 12A ACDC	2479880000	MCB 1077 3P B 12A ACDC
13	2479410000	MCB 1077 1P B 13A ACDC	2479650000	MCB 1077 2P B 13A ACDC	2479890000	MCB 1077 3P B 13A ACDC
15	2479420000	MCB 1077 1P B 15A ACDC	2479660000	MCB 1077 2P B 15A ACDC	2479900000	MCB 1077 3P B 15A ACDC
16	2479430000	MCB 1077 1P B 16A ACDC	2479670000	MCB 1077 2P B 16A ACDC	2479910000	MCB 1077 3P B 16A ACDC
20	2479440000	MCB 1077 1P B 20A ACDC	2479680000	MCB 1077 2P B 20A ACDC	2479920000	MCB 1077 3P B 20A ACDC
25	2479450000	MCB 1077 1P B 25A ACDC	2479690000	MCB 1077 2P B 25A ACDC	2479930000	MCB 1077 3P B 25A ACDC
30	2479460000	MCB 1077 1P B 30A ACDC	2479700000	MCB 1077 2P B 30A ACDC	2479940000	MCB 1077 3P B 30A ACDC
32	2515120000	MCB 1077 1P B 32A ACDC	2515130000	MCB 1077 2P B 32A ACDC	2515140000	MCB 1077 3P B 32A ACDC
35	2479470000	MCB 1077 1P B 35A ACDC	2479710000	MCB 1077 2P B 35A ACDC	2479950000	MCB 1077 3P C 35A ACDC
40	2479480000	MCB 1077 1P B 40A ACDC	2479720000	MCB 1077 2P B 40A ACDC	2479960000	MCB 1077 3P C 40A ACDC
50	2479490000	MCB 1077 1P B 50A ACDC	2479730000	MCB 1077 2P B 50A ACDC	2479970000	MCB 1077 3P C 50A ACDC
60	2479500000	MCB 1077 1P B 60A ACDC	2479740000	MCB 1077 2P B 60A ACDC	2479980000	MCB 1077 3P C 60A ACDC
63	2479510000	MCB 1077 1P B 63A ACDC	2479750000	MCB 1077 2P B 63A ACDC	2479990000	MCB 1077 3P C 63A ACDC

MCB 1077 Product Selection

C Curve - UL 1077 DIN-Rail Supplementary Circuit Breakers

(See Curve Drawings on page 13 and 14)

Amps Rating	1 Pole		2 Pole		3 Pole	
	Order No.	Description	Order No.	Description	Order No.	Description
1	2480000000	MCB 1077 1P C 1A ACDC	2480240000	MCB 1077 2P C 1A ACDC	2480480000	MCB 1077 3P C 1A ACDC
1.2	2480010000	MCB 1077 1P C 1.2A ACDC	2480250000	MCB 1077 2P C 1.2A ACDC	2480490000	MCB 1077 3P C 1.2A ACDC
1.5	2480020000	MCB 1077 1P C 1.5A ACDC	2480260000	MCB 1077 2P C 1.5A ACDC	2480500000	MCB 1077 3P C 1.5A ACDC
1.6	2480030000	MCB 1077 1P C 1.6A ACDC	2480270000	MCB 1077 2P C 1.6A ACDC	2480510000	MCB 1077 3P C 1.6A ACDC
2	2480040000	MCB 1077 1P C 2A ACDC	2480280000	MCB 1077 2P C 2A ACDC	2480520000	MCB 1077 3P C 2A ACDC
3	2480050000	MCB 1077 1P C 3A ACDC	2480290000	MCB 1077 2P C 3A ACDC	2480530000	MCB 1077 3P C 3A ACDC
4	2480060000	MCB 1077 1P C 4A ACDC	2480300000	MCB 1077 2P C 4A ACDC	2480540000	MCB 1077 3P C 4A ACDC
5	2480070000	MCB 1077 1P C 5A ACDC	2480310000	MCB 1077 2P C 5A ACDC	2480550000	MCB 1077 3P C 5A ACDC
6	2480080000	MCB 1077 1P C 6A ACDC	2480320000	MCB 1077 2P C 6A ACDC	2480560000	MCB 1077 3P C 6A ACDC
7	2515060000	MCB 1077 1P C 7A ACDC	2515070000	MCB 1077 2P C 7A ACDC	2515080000	MCB 1077 3P C 7A ACDC
8	2480090000	MCB 1077 1P C 8A ACDC	2480330000	MCB 1077 2P C 8A ACDC	2480570000	MCB 1077 3P C 8A ACDC
10	2480100000	MCB 1077 1P C 10A ACDC	2480340000	MCB 1077 2P C 10A ACDC	2480580000	MCB 1077 3P C 10A ACDC
12	2480110000	MCB 1077 1P C 12A ACDC	2480350000	MCB 1077 2P C 12A ACDC	2480590000	MCB 1077 3P C 12A ACDC
13	2480120000	MCB 1077 1P C 13A ACDC	2480360000	MCB 1077 2P C 13A ACDC	2480600000	MCB 1077 3P C 13A ACDC
15	2480130000	MCB 1077 1P C 15A ACDC	2480370000	MCB 1077 2P C 15A ACDC	2480610000	MCB 1077 3P C 15A ACDC
16	2480140000	MCB 1077 1P C 16A ACDC	2480380000	MCB 1077 2P C 16A ACDC	2480620000	MCB 1077 3P C 16A ACDC
20	2480150000	MCB 1077 1P C 20A ACDC	2480390000	MCB 1077 2P C 20A ACDC	2480630000	MCB 1077 3P C 20A ACDC
25	2480160000	MCB 1077 1P C 25A ACDC	2480400000	MCB 1077 2P C 25A ACDC	2480640000	MCB 1077 3P C 25A ACDC
30	2480170000	MCB 1077 1P C 30A ACDC	2480410000	MCB 1077 2P C 30A ACDC	2480650000	MCB 1077 3P C 30A ACDC
32	2480180000	MCB 1077 1P C 32A ACDC	2480420000	MCB 1077 2P C 32A ACDC	2480660000	MCB 1077 3P C 32A ACDC
35	2480190000	MCB 1077 1P C 35A ACDC	2480430000	MCB 1077 2P C 35A ACDC	2480670000	MCB 1077 3P C 35A ACDC
40	2480200000	MCB 1077 1P C 40A ACDC	2480440000	MCB 1077 2P C 40A ACDC	2480680000	MCB 1077 3P C 40A ACDC
50	2480210000	MCB 1077 1P C 50A ACDC	2480450000	MCB 1077 2P C 50A ACDC	2480690000	MCB 1077 3P C 50A ACDC
60	2480220000	MCB 1077 1P C 60A ACDC	2480460000	MCB 1077 2P C 60A ACDC	2480700000	MCB 1077 3P C 60A ACDC
63	2480230000	MCB 1077 1P C 63A ACDC	2480470000	MCB 1077 2P C 63A ACDC	2480710000	MCB 1077 3P C 63A ACDC

MCB 1077 Product Selection

D Curve – UL 1077 DIN-Rail Supplementary Circuit Breakers

(See Curve Drawings on page 13 and 14)

Amps Rating	1 Pole		2 Pole		3 Pole	
	Order No.	Description	Order No.	Description	Order No.	Description
1	2480720000	MCB 1077 1P D 1A ACDC	2480960000	MCB 1077 2P D 1A ACDC	2481200000	MCB 1077 3P D 1A ACDC
1.2	2480730000	MCB 1077 1P D 1.2A ACDC	2480970000	MCB 1077 2P D 1.2A ACDC	2481210000	MCB 1077 3P D 1.2A ACDC
1.5	2480740000	MCB 1077 1P D 1.5A ACDC	2480980000	MCB 1077 2P D 1.5A ACDC	2481220000	MCB 1077 3P D 1.5A ACDC
1.6	2480750000	MCB 1077 1P D 1.6A ACDC	2480990000	MCB 1077 2P D 1.6A ACDC	2481230000	MCB 1077 3P D 1.6A ACDC
2	2480760000	MCB 1077 1P D 2A ACDC	2481000000	MCB 1077 2P D 2A ACDC	2481240000	MCB 1077 3P D 2A ACDC
3	2480770000	MCB 1077 1P D 3A ACDC	2481010000	MCB 1077 2P D 3A ACDC	2481250000	MCB 1077 3P D 3A ACDC
4	2480780000	MCB 1077 1P D 4A ACDC	2481020000	MCB 1077 2P D 4A ACDC	2481260000	MCB 1077 3P D 4A ACDC
5	2480790000	MCB 1077 1P D 5A ACDC	2481030000	MCB 1077 2P D 5A ACDC	2481270000	MCB 1077 3P D 5A ACDC
6	2480800000	MCB 1077 1P D 6A ACDC	2481040000	MCB 1077 2P D 6A ACDC	2481280000	MCB 1077 3P D 6A ACDC
7	2515090000	MCB 1077 1P D 7A ACDC	2515100000	MCB 1077 2P D 7A ACDC	2481290000	MCB 1077 3P D 7A ACDC
8	2480810000	MCB 1077 1P D 8A ACDC	2481050000	MCB 1077 2P D 8A ACDC	2481300000	MCB 1077 3P D 8A ACDC
10	2480820000	MCB 1077 1P D 10A ACDC	2481060000	MCB 1077 2P D 10A ACDC	2481310000	MCB 1077 3P D 10A ACDC
12	2480830000	MCB 1077 1P D 12A ACDC	2481070000	MCB 1077 2P D 12A ACDC	2481320000	MCB 1077 3P D 12A ACDC
13	2480840000	MCB 1077 1P D 13A ACDC	2481080000	MCB 1077 2P D 13A ACDC	2481330000	MCB 1077 3P D 13A ACDC
15	2480850000	MCB 1077 1P D 15A ACDC	2481090000	MCB 1077 2P D 15A ACDC	2481340000	MCB 1077 3P D 15A ACDC
16	2480860000	MCB 1077 1P D 16A ACDC	2481100000	MCB 1077 2P D 16A ACDC	2481350000	MCB 1077 3P D 16A ACDC
20	2480870000	MCB 1077 1P D 20A ACDC	2481110000	MCB 1077 2P D 20A ACDC	2481360000	MCB 1077 3P D 20A ACDC
25	2480880000	MCB 1077 1P D 25A ACDC	2481120000	MCB 1077 2P D 25A ACDC	2481370000	MCB 1077 3P D 25A ACDC
30	2480890000	MCB 1077 1P D 30A ACDC	2481130000	MCB 1077 2P D 30A ACDC	2481380000	MCB 1077 3P D 30A ACDC
32	2480900000	MCB 1077 1P D 32A ACDC	2481140000	MCB 1077 2P D 32A ACDC	2481390000	MCB 1077 3P D 32A ACDC
35	2480910000	MCB 1077 1P D 35A ACDC	2481150000	MCB 1077 2P D 35A ACDC	2481400000	MCB 1077 3P D 35A ACDC
40	2480920000	MCB 1077 1P D 40A ACDC	2481160000	MCB 1077 2P D 40A ACDC	2481410000	MCB 1077 3P D 40A ACDC
50	2480930000	MCB 1077 1P D 50A ACDC	2481170000	MCB 1077 2P D 50A ACDC	2481420000	MCB 1077 3P D 50A ACDC
60	2480940000	MCB 1077 1P D 60A ACDC	2481180000	MCB 1077 2P D 60A ACDC	2481430000	MCB 1077 3P D 60A ACDC
63	2480950000	MCB 1077 1P D 63A ACDC	2481190000	MCB 1077 2P D 63A ACDC	2481440000	MCB 1077 3P D 63A ACDC

Trip Curves

Trip curves B, C, D – overcurrent protection of cables in accordance with IEC/EN 60898-1 and IEC 60947-2

Time/current characteristics

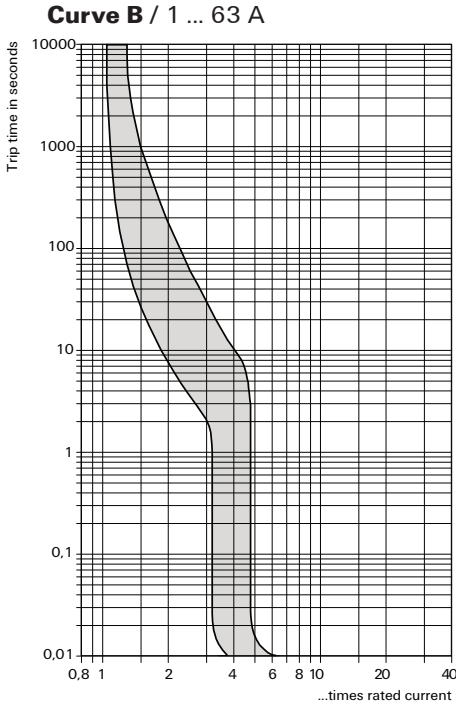

Magnetic tripping currents are increased by 30 % on DC supplies.
Ambient temperature 30 °C

Trip between 3-5X rated current (30-50 Amp for a 10 Amp device)

Residential and light commercial applications such as:

- Resistive loads (low surge current)
- Low switching surge current
- Wire protection
- Lighting
- Appliances

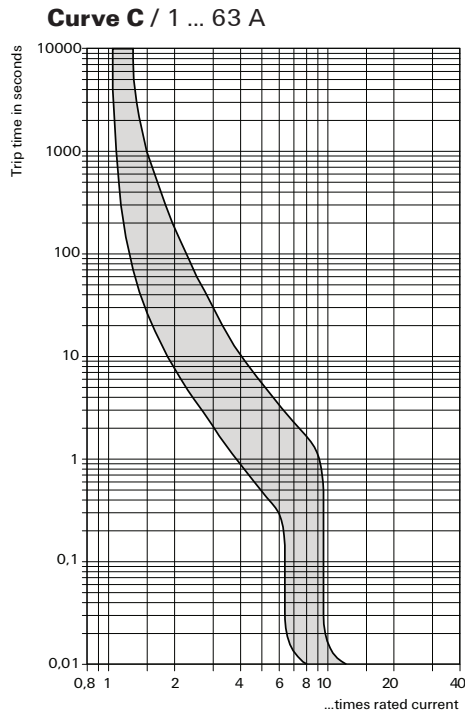

Magnetic tripping currents are increased by 30 % on DC supplies.
Ambient temperature 30 °C

Trip between 5-10X rated current (50-100 Amp for a 10 Amp device)

Commercial applications such as:

- Inductive loads
- Motors (low inrush current)
- Control circuitry
- Lighting
- Appliances

Curve D / 1 ... 63 A

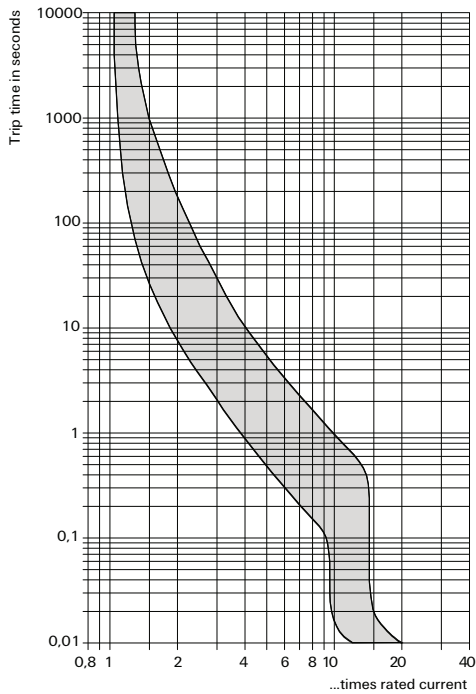

Magnetic tripping currents are increased by 30 % on DC supplies.
Ambient temperature 30 °C

**Trip between 10-20X rated current
(100-200 Amp for a 10 Amp device)**

Industrial applications such as:

- High inductive and capacitive loads
- Motors (higher inrush current)
- Power supplies
- Transformers
- Heaters
- X-ray machines
- Reactive loads

Current ratings and voltage drop at +25°C

Voltage drop in V at 1 I _N						
I _N (A)	1	1.2	1.5	1.6	2	3
V	1.50	1.50	0.80	0.80	0.80	0.60
I _N (A)	4	5	6	7	8	10
V	0.60	0.20	0.20	0.20	0.15	0.15
I _N (A)	12	13	15	16	20	25
V	0.15	0.10	0.10	0.10	0.08	0.08
I _N (A)	30	32	35	40	50	60
V	0.07	0.07	0.07	0.07	0.06	0.06
I _N (A)	63					
V	0.06					

Note: When mounted side-by-side, the breakers can only carry up to 80% of their rated current or a higher rating has to be selected

Accessories

Auxiliary contact

Description

Add-on module for circuit breaker type MCB 498 and MCB 1077. The auxiliary switch has a change-over contact as signal contact and is operated with actuation of the MCB. The module has screw terminals and is rated for AC and DC voltages.

Typical Applications

Status monitoring of MCB and/or the connected loads.



Description	Order No.
MCB AUX Contact 1NC	7940099227

Technical Data

Rated currents to IEC/EN 60947-5-1:					
Voltage ratings:	AC 240 V	AC 415 V	DC 24 V	DC 48 V	DC 130 V
Current ratings:	6 A	3 A	6 A	2 A	1 A
Rated currents to UL 489:					
Voltage ratings:	AC 12 ... 240 V	AC 277 V	DC 12 ... 24 V	DC 48 V	DC 110 ... 220 V
Current ratings:	6 A	3 A	6 A	3 A	1.5 A
Typical life	20,000 cycles				
Tightening torque	1 Nm max.				
Ambient temperature	-35°C ...+70°C				
Width	9 mm				
Mass	approx. 29 g				

Approvals

Approval authority	Standard
TÜV	IEC/EN 60947-5-1
UL	UL 489

Schematic Diagrams

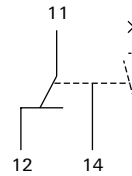

Note:

As soon as the auxiliary contact module is mounted on the MCB, the terminals 11 and 14 are connected when the MCB is in ON condition. Terminals 11 and 12 are connected when the MCB is in OFF condition.

Dimensions (in millimeters)

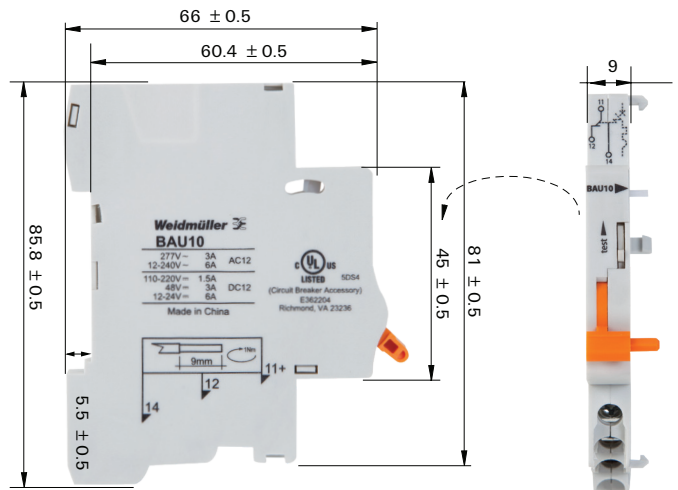

Bell alarm contact

Description

Add-on module for MCB 498 and MCB 1077. The bell alarm contact has a change-over contact as signal contact. There will only be a signal when the MCB tripped on grounds of a failure (overload, short circuit), but and not when the MCB was switched on or off manually.

By actuating the reset lever on the front the tripping signal is acknowledged.

Typical Applications

Status monitoring of MCB and/or the connected loads.

Mounting

The add-on module is mounted on the left side of the MCB (seen from the front). For mounting, the MCB has to be in the OFF position.

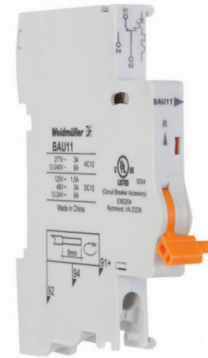

Description	Order No.
MCB/AUX Bell Alarm Contact 1NC/1NO	7940099228

Technical Data

Rated currents to IEC/EN 60947-5-1:					
Voltage ratings:	AC 240 V	AC 415 V	DC 24 V	DC 48 V	DC 130 V
Current ratings:	6 A	3 A	6 A	2 A	1 A
Rated currents to UL 489:					
Voltage ratings:	AC 12 ... 240 V	AC 277 V	DC 12 ... 24 V	DC 48 V	DC 110 ... 220 V
Current ratings:	6 A	3 A	6 A	3 A	1.5 A
Typical life	20,000 cycles				
Tightening torque	1 Nm max.				
Ambient temperature	-35°C ...+70°C				
Width	9 mm				
Mass	approx. 29 g				

Approvals

Approval authority	Standard
UL	UL 489

Schematic Diagrams

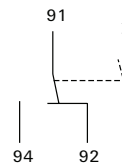

Note:

As soon as the bell alarm contact module is mounted on the MCB, the terminals 91 and 92 are connected when the MCB is in ON condition; the terminals 91 and 94 are connected when the MCB tripped electrically; the terminals 91 and 92 are connected when the MCB was tripped manually; at the same time the terminals 91 and 94 do not have contact.

Dimensions (in millimeters)

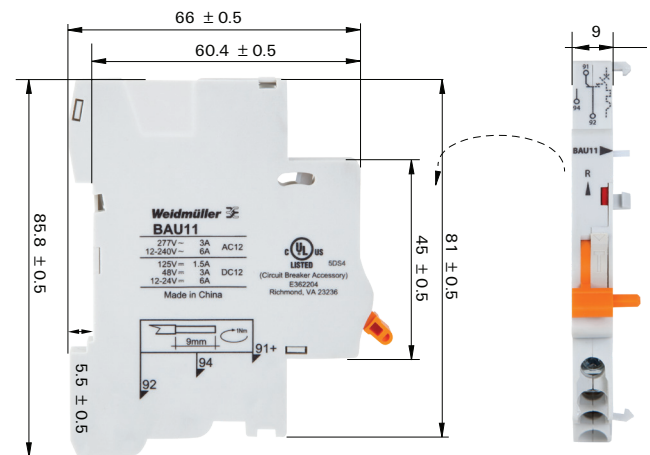

Shunt Trip

Description

Add-on module for MCB type BR/SUxxxUC. The shunt trip module serves for remote trip of the MCB and for signalling whether the MCB was tripped electrically or manually.

Typical Applications

Electrical remote trip of safety equipment with simultaneous monitoring of MCB status or its connected load.

Mounting

The add-on module is mounted on the left side of the MCB (seen from the front). For mounting, the MCB has to be in the OFF position. When auxiliary contact module/bell alarm contact module and a shunt trip module are mounted at the same time, the shunt trip module always has to be mounted first.

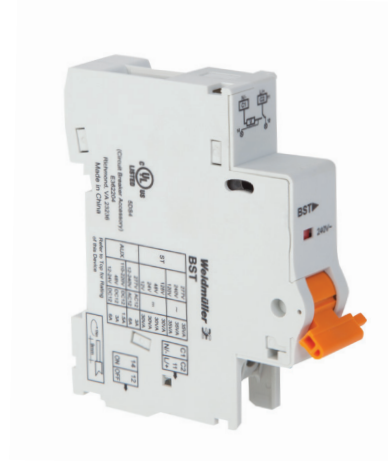

Description	Order No.
MCB SHUNT 1NC/1NO 12VDC	7940104512
MCB SHUNT 1NC/1NO 24VDC	7940099319
MCB SHUNT 1NC/1NO 48VDC	7940104515
MCB SHUNT 1NC/1NO 125VDC	7940104511
MCB SHUNT 1NC/1NO 120VA VAC	7940104510
MCB SHUNT 1NC/1NO 240VA VAC	7940104513
MCB SHUNT 1NC/1NO 277VA VAC	7940104514

Technical Data

	AC 277 V	AC 240 V	AC 120 V	
Voltage ratings AC	AC 277 V	AC 240 V	AC 120 V	
Min. trip voltage	AC 160 V	AC 160 V	AC 80 V	
Power consumption	240 W	200 W	200 W	
min. response power	35 W	35 W	35 W	
Rated current of auxiliary contact	3 A	6 A	6 A	
Voltage ratings DC	DC 125 V	DC 48 V	DC 24 V	DC 12 V
Min. trip voltage	DC 80 V	DC 24 V	DC 16 V	DC 8 V
Power consumption	200 W	200 W	200 W	200 W
min. response power	30 VA	30 VA	30 VA	30 VA
Rated current of auxiliary contact	1.5 A	2 A	6 A	6 A
Trip time	< 10 ms			
Typical life	20,000 cycles			
Tightening torque	1 Nm max.			
Ambient temperature	-35°C...+70°C			
Width	18 mm			
Mass	approx. 60 g			

Approvals

Approval authority	Standard
UL	UL 489

Schematic Diagrams

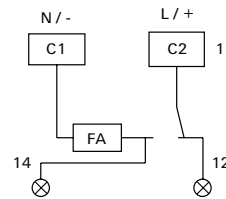

Dimensions (in millimeters)

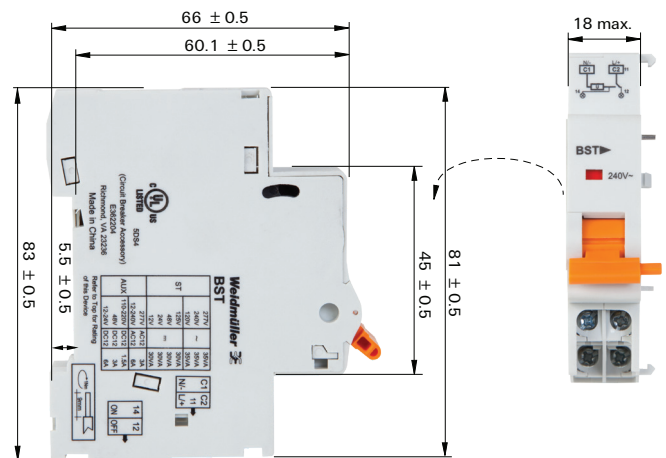

Accessories

Accessory modules installation diagram

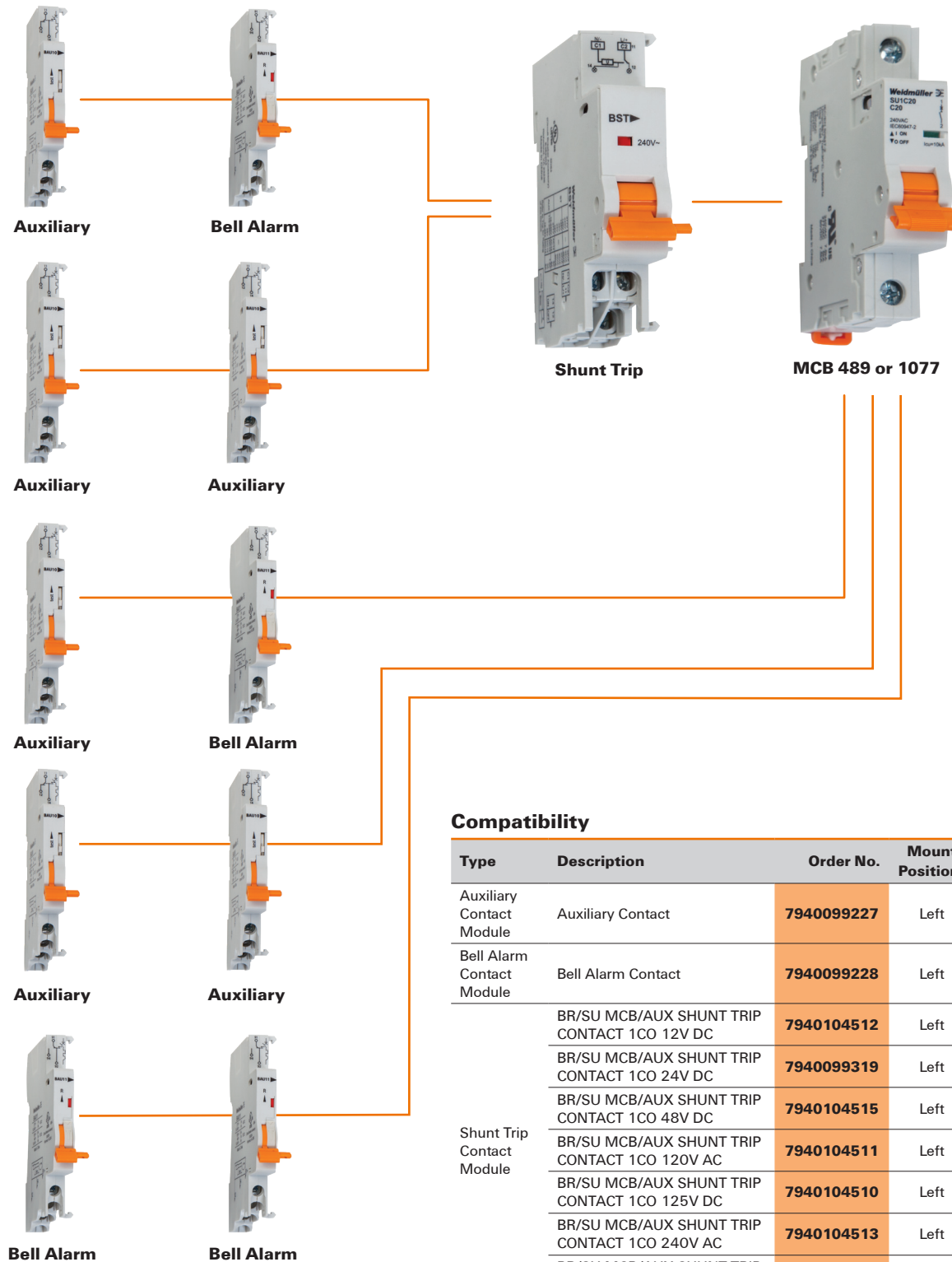

Compatibility

Type	Description	Order No.	Mount Position*	MCB 489	MCB 1077
Auxiliary Contact Module	Auxiliary Contact	7940099227	Left	X	X
Bell Alarm Contact Module	Bell Alarm Contact	7940099228	Left	X	X
Shunt Trip Contact Module	BR/SU MCB/AUX SHUNT TRIP CONTACT 1CO 12V DC	7940104512	Left	X	X
	BR/SU MCB/AUX SHUNT TRIP CONTACT 1CO 24V DC	7940099319	Left	X	X
	BR/SU MCB/AUX SHUNT TRIP CONTACT 1CO 48V DC	7940104515	Left	X	X
	BR/SU MCB/AUX SHUNT TRIP CONTACT 1CO 120V AC	7940104511	Left	X	X
	BR/SU MCB/AUX SHUNT TRIP CONTACT 1CO 125V DC	7940104510	Left	X	X
	BR/SU MCB/AUX SHUNT TRIP CONTACT 1CO 240V AC	7940104513	Left	X	X
	BR/SU MCB/AUX SHUNT TRIP CONTACT 1CO 277V AC	7940104514	Left	X	X

*Seen from the front

Mounting instructions for the accessory modules

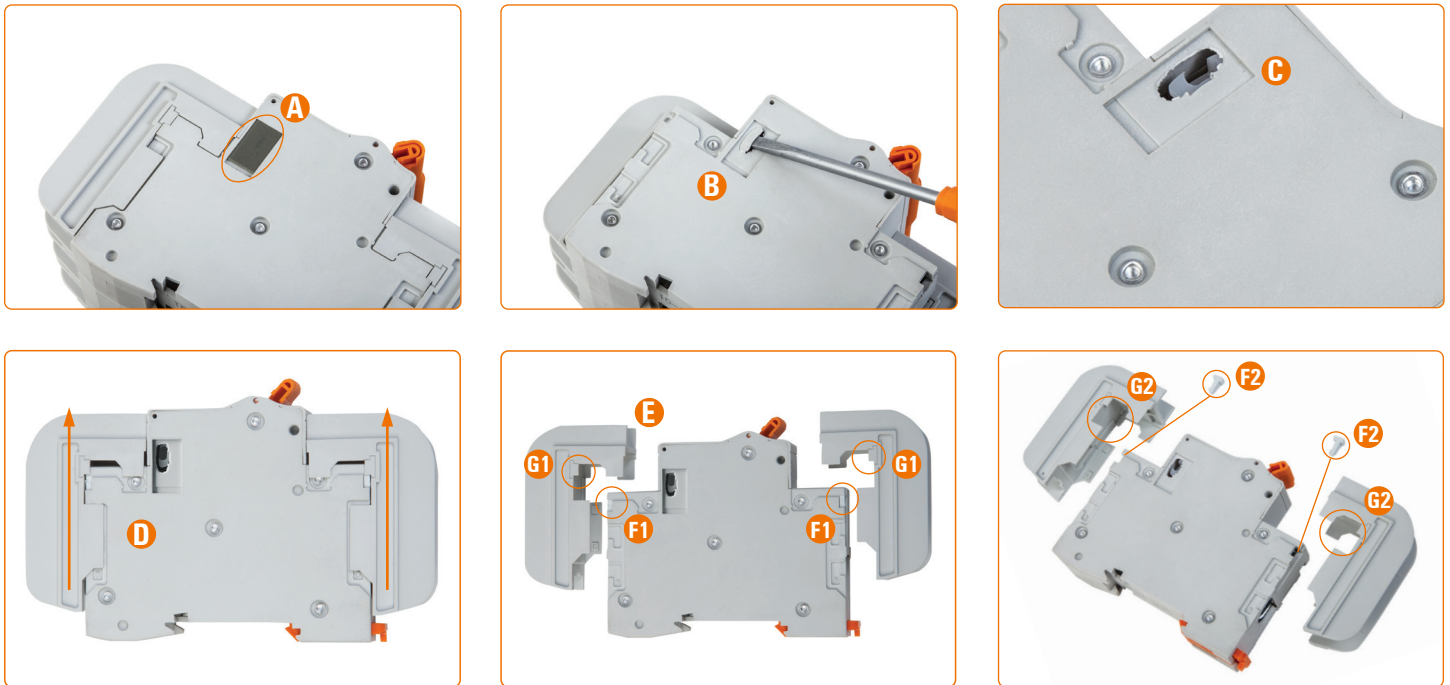

Preparing the MCB to connect the Auxiliary Contact, Bell Alarm Contact or Shunt Trip Module

- Use a small flat screwdriver to remove the clear plastic window (A) on the left side of the MCB (seen from the front). Do not remove the clear plastic window on the right side.
- Use the same screwdriver to remove the solid plastic cover (B) exposing the mechanical trip mechanism (C) beneath the window.
- For the MCB 489's only, slide the top and bottom fins forward and remove (D, E).
- For the MCB 489's, using small pliers remove the 2 plastic tabs on the fins (G1) and remove the 2 plugs from the breaker (F1) on the left side only.
 - For the MCB 1077's, using small pliers remove the plugs from the breaker (F1).
 - G2 shows the plastic tabs removed and F2 shows the plugs removed.
- For the MCB 489's only, reattach the fins after installing the accessory module(s).

Accessory devices are left hand mounted only (seen from the front).

Accessories for Branch and Supplementary Circuit Breakers

Applies to 7940099227, 7940099228 and BST:

The accessory modules can be installed on the left side only (seen from the front).

Mounting

1. Bring all orange levers of all devices into the "OFF" position
2. Insert guide pin into the lever handle notch (insertion depth approx. 7 mm)
3. Combine MCB and 7940099227, 7940099228 or BST as outlined on page 18
4. Installation is complete when all snap together

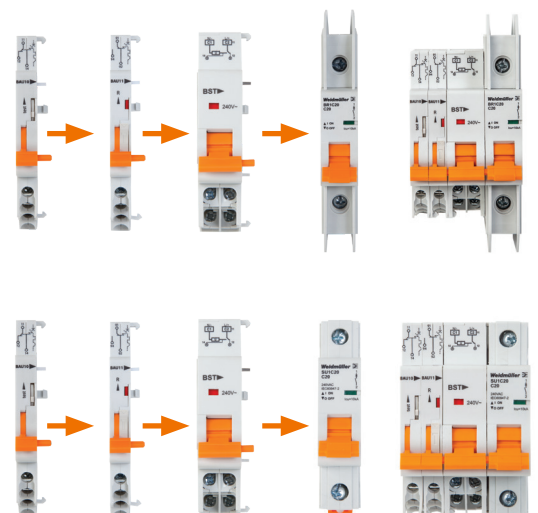

Accessories

Busbar and busbar accessories

Busbars UL 489 – cuttable

Description

Busbars for the connection of circuit breakers type MCB489 to UL 489. The busbars of 1 meter length can individually be cut to a suitable length for the application and isolated with end caps. Depending on the control cabinet design, the supply is by means of supply terminals without increasing the installation width or by means of a terminal block directly on the rail without increasing the installation height.

Three busbar models are available for use with auxiliary contact modules with a width of 9 mm.

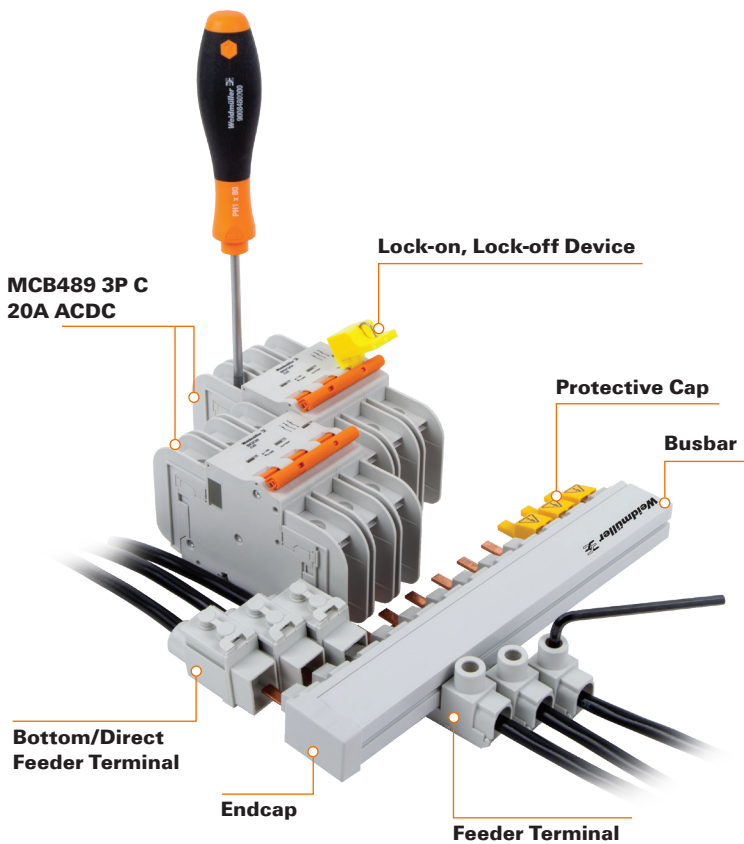

How to prepare the cuttable busbar

1. The busbar can be cut to individually required lengths for maximum flexibility



2. After cutting, clean the cut face

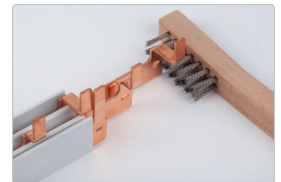

3. Attach an end cap for maximum finger safety

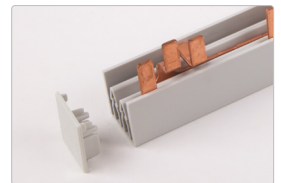

Technical Data

Order No.	No. of Poles	No. of Devices	No. of Pins	Cross Section	Max. Amperage	Max. Voltage	Pitch
7940099236	1	57	57	18 mm ²	80 A	1000 V AC/DC	17.6 mm
7940099238	2	28	56			600 V AC/DC	
7940104509	3	19	57			600 V AC/DC	
7940099235*	1	37	37			1000 V AC/DC	
7940104506**	2	23	46			600 V AC/DC	
7940104508***	3	16	48			600 V AC/DC	

*, **, ***See Ordering Data

Voltage Ratings	Single Phase	2 and 3 Phase
Max. AC Voltage	1000 V AC	600 V AC
Max. DC Voltage	1000 V DC	600 V DC
Current Ratings	End Feed	Center Feed
Max. Current 18 mm ² Cross Section	80 A	160 A†
Protection Class	IP20	
kA Rating (J Fuse)	14kA	

†Note: Two 115 A Feeder Terminals required per phase

Ordering Data

No. of Poles	No. of Devices	No. of Pins	Description	Order No.
1-Pole	12	12	MCB BUS BAR UL489 1 POLE 12 PIN	7940099234
	18	18	MCB BUS BAR UL489 1 POLE 18 PIN	7940104504
	57	57	MCB BUS BAR UL489 1 POLE 57 PIN	7940099236
2-Pole	6	12	MCB BUS BAR UL489 2 POLE 12 PIN	7940099237
	9	18	MCB BUS BAR UL489 2 POLE 18 PIN	7940104505
	28	56	MCB BUS BAR UL489 2 POLE 56 PIN	7940099238
3-Pole	4	12	MCB BUS BAR UL489 3 POLE 12 PIN	7940099239
	6	18	MCB BUS BAR UL489 3 POLE 18 PIN	7940104507
	19	57	MCB BUS BAR UL489 3 POLE 57 PIN	7940104509
*1-Pole with Auxiliary Module Spacing	37	37	MCB BUS BAR UL489 1 POLE 37 PIN AUX	7940099235
**2-Pole with Auxiliary Module Spacing	23	46	MCB BUS BAR UL489 2 POLE 46 PIN AUX	7940104506
***3-Pole with Auxiliary Module Spacing	16	48	MCB BUS BAR UL489 3 POLE 48 PIN AUX	7940104508

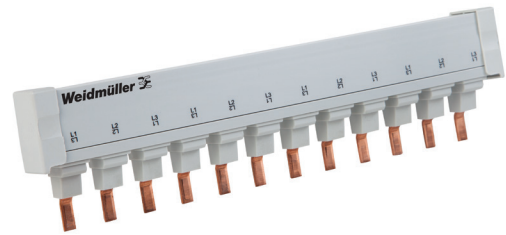

Feeder Terminal



Bottom/Direct Feeder Terminal



Endcap



Protective Cap

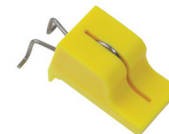

Lock-on, Lock-off Device

Accessories for Busbars UL 489

Description	Order No.
Feeder Terminal, UL 489, 115 A	7940099232

Description	Order No.
Bottom/Direct Feeder Terminal, UL 489, 115 A	7940099233

Description	Order No.
Endcap for UL 489 Cutable Busbar	7940099230

Description	Order No.
Protective Cap for UL 489 cuttable busbar, 3 caps per bar	7940099231

Description	Order No.
Lock-on, Lock-off Device	7940099734

Busbars UL 1077 – cuttable

Description

Busbars for the connection of circuit breakers type MCB1077 to UL 1077. The busbars of 1 meter length can individually be cut to a suitable length for the application and isolated with end caps. Depending on the control cabinet design, the supply is by means of supply terminals without increasing the installation width or by means of a terminal block directly on the rail without increasing the installation height.

Three busbar models are available for use with auxiliary contact modules with a width of 9 mm.

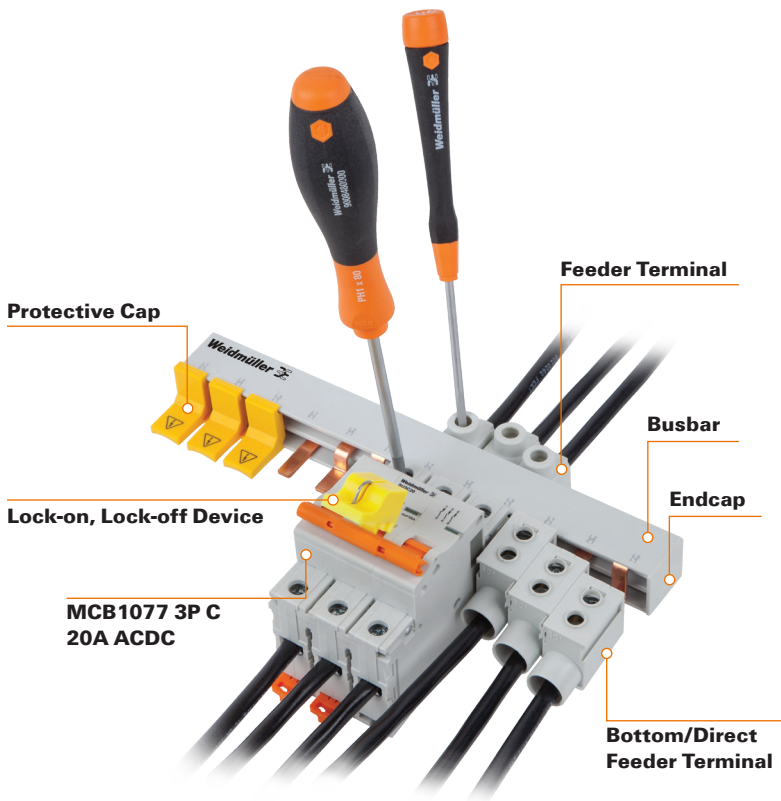

How to prepare the cuttable busbar

1. Use a saw to cut the busbar to the desired length



2. Slide the copper bars from the insulation and cut back the bars for proper end clearances



3. Deburr the edges

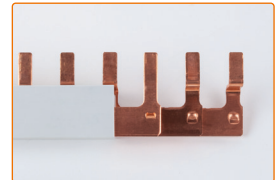

4. Use a stiff brush or compressed air to remove any copper or plastic filings and reassemble the busbar

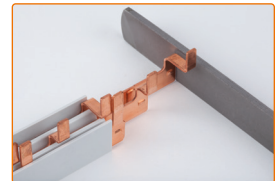

5. Attach endcaps

Note: For safety purposes, all shortened busbars need to be covered with suitable endcaps

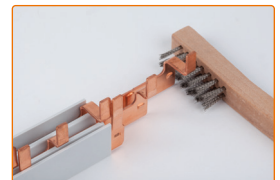

Technical Data

Voltage Ratings	Single Phase	2 and 3 Phase
Max. AC Voltage	1000 V AC	600 V AC
Max. DC Voltage	1000 V DC	600 V DC
Current Ratings	End Feed	Center Feed
Max. Current 18 mm ² Cross Section	80 A	160 A†
Protection Class	IP20	
kA Rating (J Fuse)	14kA	

†Note: Two 115 A Feeder Terminals required per phase

Ordering Data

No. of Poles	No. of Devices	No. of Pins	Description	Order No.
1-Pole	12	12	MCB BUS BAR UL1077 1 POLE 12 PIN	7940099008
	18	18	MCB BUS BAR UL1077 1 POLE 18 PIN	7940104908
	57	57	MCB BUS BAR UL1077 1 POLE 57 PIN	7940104909
2-Pole	6	12	MCB BUS BAR UL1077 2 POLE 12 PIN	7940099133
	9	18	MCB BUS BAR UL1077 2 POLE 18 PIN	7940099417
	28	56	MCB BUS BAR UL1077 2 POLE 56 PIN	7940104910
3-Pole	4	12	MCB BUS BAR UL1077 3 POLE 12 PIN	7940099195
	6	18	MCB BUS BAR UL1077 3 POLE 18 PIN	7940104912
	19	57	MCB BUS BAR UL1077 3 POLE 57 PIN	7940099418
1-Pole with Auxiliary Module Spacing	37	37	MCB BUS BAR UL1077 1 POLE 37 PIN AUX	7940099415
2-Pole with Auxiliary Module Spacing	23	46	MCB BUS BAR UL1077 2 POLE 46 PIN AUX	7940104911
3-Pole with Auxiliary Module Spacing	16	48	MCB BUS BAR UL1077 3 POLE 48 PIN AUX	7940104913

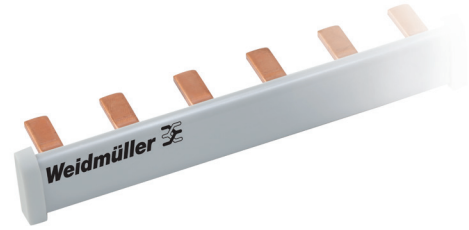

1P Top Feed Terminal



2/3P Top Feed Terminal



Bottom/Direct Feeder Terminal

Top Feed Terminal

Description	Order No.
MCB BUS BAR UL1077 1P TERM TOP FEED	7940104937
MCB BUS BAR UL1077 2/3P TERM TOP FEED	7940099078

Bottom/Direct Feeder Terminal

Description	Order No.
MCB BUS BAR UL1077 1/2/3P TERM BOT FEED	7940099453

Endcap

Description	Order No.
MCB BUS BAR UL1077 1P END CAP	7940099060
MCB BUS BAR UL1077 2/3P END CAP	7940099223



Endcap

Protective Cap

Description	Order No.
MCB BUS BAR UL1077 BUS CAP YEL (5 caps)	7940099216



Protective Cap

Lock-on, Lock-off Device

Description	Order No.
Lock-on, Lock-off Device	7940099734

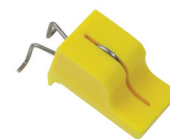

Lock-on, Lock-off Device

Glossary

Weidmuller MCB489 and MCB1077 Series breakers are UL tested and certified as current limiting protective devices. Current limiting circuit breakers provide a higher level of circuit protection than a typical zero point external breakers.

Ampere Rating

A rating of the amount of current a protective device will carry continuously without deteriorating or exceeding temperature rise limits.

Arc

The effect generated when electrical current bridges the air gap between two conductors that are not touching.

Branch Circuit

The conductor and components following the last over-current protective device protecting a load.

Circuit Breaker

A device designed to open and close a circuit by non-automatic means, and to open the circuit automatically on a pre-determined overcurrent, without damage to itself when properly applied within its rating.

Current Limiting

A type of supplementary protector which limits the amount of damaging short circuit current.

DIN-Rail

A solidly mounted, rail-type device to which any number of circuit breakers can be mounted.

Double Pole

Term used to describe a breaker that draws power from two poles of a load center or similar device.

Frame

A component of a miniature circuit breaker. Its primary function is to provide a rigid, mechanically strong, insulated housing in which the other components are mounted.

IEC

Abbreviation for International Electrotechnical Commission. This organization is associated with equipment used internationally.

IEC 60947-2 Current Limiting Circuit Breaker

A circuit breaker with sufficiently short trip time to prevent the short circuit current from reaching the peak value which would otherwise be reached.

Interrupting Rating

The highest current, at rated voltage, that a device is intended to interrupt under standard test conditions.

Let-through Current

The maximum instantaneous or peak current which passes through a protective device.

Load Center

A device that delivers electricity from a supply source to loads in light commercial or residential applications.

Miniature Circuit Breaker (MCB)

A specific type of circuit breaker, used to switch and protect the lowest common distribution voltage in an electrical system. Generally used in a load center, panelboard or similar device.

NEC

Abbreviation for National Electrical Code. A standard for applying electrical equipment in the United States.

NEC240.2 Current Limiting

A device that, when interrupting current in its current-limiting range, reduces the current flowing in the faulted circuit to a magnitude substantially less than that obtainable in the same circuit if the device were replaced with a solid conductor having comparable impedance.

Operating Mechanism

A component of a miniature circuit breaker. Its function is to provide the means of opening and closing the circuit.

Overcurrent Protective Device

A device such as a circuit breaker or fuse. In the event of an overload or short circuit, this device will quickly terminate power to the circuit.

Overload (or Overcurrent)

A condition in which current is in excess of the normal load being drawn.

Short Circuit

An electrical fault created when two exposed conductors touch.

Single Pole

Term used to describe a breaker that draws power from one pole of a load center or similar device.

Supplementary Protector

A device similar in function to a miniature circuit breaker, but not UL approved as a circuit breaker. Used in conjunction with circuit breakers.

Thermal Magnetic

The predominant trip unit technology used in the domestic market. A bimetal and an electromagnet work together to provide overload and short circuit protection.

UL AC 60Hz Cycle

UL defines an AC cycle as the potential energy of the wave form traveling from Zero-to-Positive amplitude, Positive-to-Zero amplitude, Zero-to-Negative amplitude, Negative-to-Zero amplitude 60 times in one second. One cycle is completed every 16.6 milliseconds.

UL Breaker Current Limiting

UL defines breaker current limitation as a breaker that interrupts and isolates a fault in less than half of an AC cycle. Half a cycle is completed in 8.3 milliseconds.

Withstand Rating

The maximum current that an unprotected electrical component can sustain for a specific period of time without the occurrence of extensive damage.

Operation and Components of MCB489 & MCB1077 ACDC Series

During normal operation and the MCB switch engaged, current flows in the line side terminal to a bimetallic strip, moving contact, fixed contact, current coil (magnetic trip coil) and out the load side terminal to complete a series path.

The MCB enclosure housing is a molded plastic material. This provides mechanical strength and insulation from the components inside. The switching system consists of a fixed and a moving contact plate to which incoming and outgoing conductors are connected. The current carrying components are made up of various metallic compounds depending on the rating of the circuit breaker.

The orange lever is used to manually engage/disengage the contact under normal ON/OFF conditions, as well as indicate status of the device. It also allows manual RESET of the latch after an overload or short circuit event.

The thermal overload configuration for the slow rising current over time consists of a strip of bimetal (two dissimilar metals). The rise in current causes a rise in temperature. The heat generated within the bimetal itself is enough to cause deflection due to thermal expansion of the dissimilar metals. This deflection further releases the trip latch mechanism and the contact faces separate.

The magnetic tripping configuration for short circuit conditions consists of a system that allow fast rise time current (too fast for the bimetal) to separate the contact faces using a spring loaded plunger. The current carrying coil in this trip configuration moves the plunger when a strong magnetic field produced by the coils releasing the plunger engaging the trip latch mechanism.

From the action of the fixed and moving contact faces separating in the event of an overload or short circuit situation, an electric arc in air is formed. The UC Series is designed to handle the arc interruption process where arc energy extraction and its cooling are provided by the arc runner and parallel arc splitter plates called the arc chute. These plates are held in position by the housing material. The operating mechanism consists of both magnetic tripping and thermal tripping arrangements.

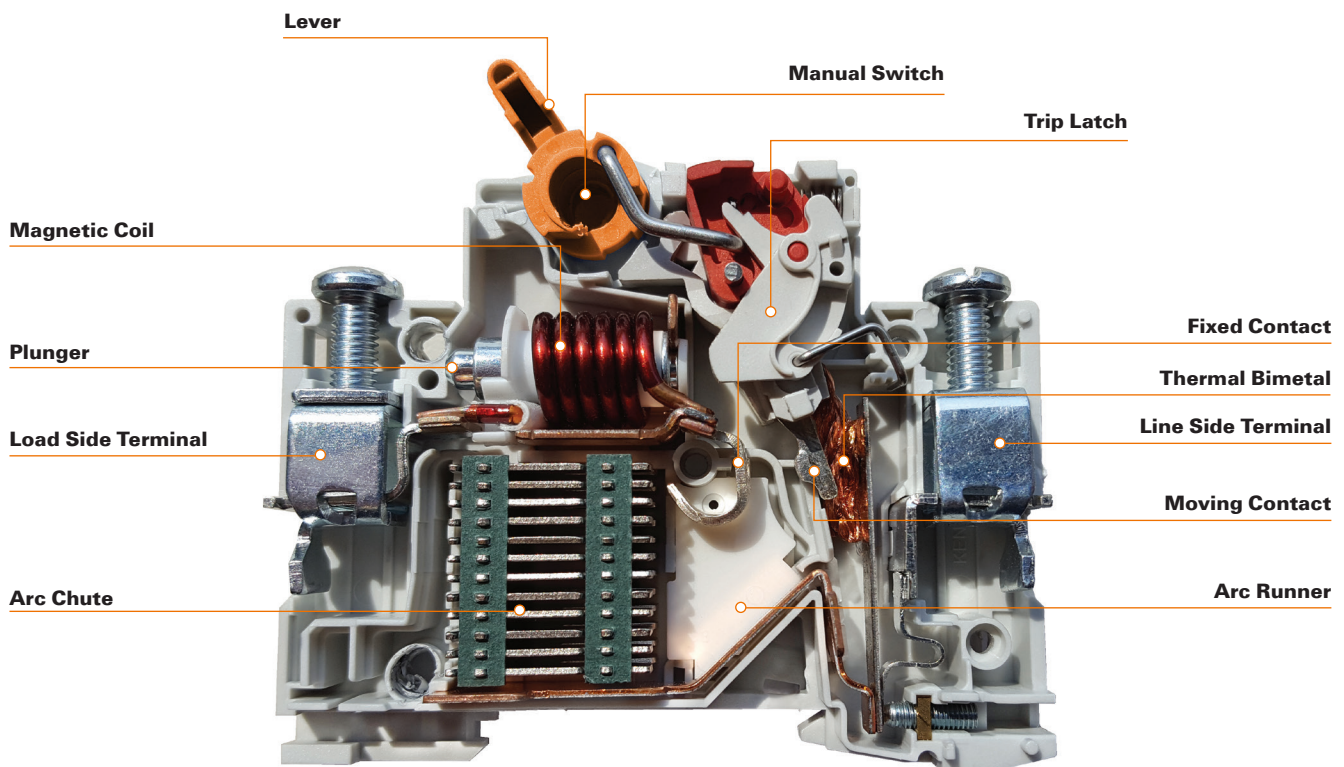

Weidmuller ACDC Series Thermal Magnetic Definition

Thermal Overload

A thermal overload is a slow and small overcurrent situation that causes the ampacity and temperature of the circuit to gradually increase. This type of event is characterized by a slight increase in the load (ampacity) on the circuit and is interrupted by the thermal trip unit of the breaker.

Thermal Region of the trip curve representing the tripping characteristics of the bimetal trip unit. The tripping region is sloped due to the gradual overload, heating, and bending nature of the thermal element over time.

Short Circuit

A short circuit is an intense overcurrent situation that causes the ampacity of the circuit to increase. This type of event is characterized by a dramatic increase in the load (ampacity) on the circuit and is interrupted by the magnetic trip unit of the breaker.

Magnetic Region of the trip curve representing the tripping characteristics of the magnetic trip unit. The tripping region is not sloped due to the instantaneous nature of the magnetic element during a short circuit.

MCBs' tripping characteristics are represented graphically in a trip curve chart. The chart shows the response of the thermal and magnetic trip element to various overload and short circuit situations.

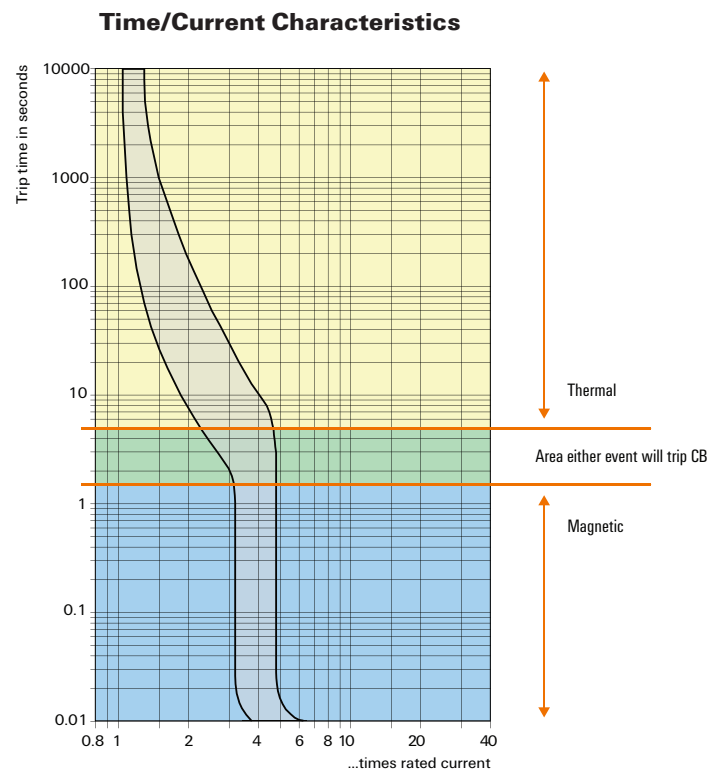

Reading trip curves – examples of trip curve interpretation

Example 1: Thermal Tripping Characteristic

10 Amp B Curve Breaker Thermal Overload at 20 Amps

To determine the time it takes for the breaker to trip with a 20 A load:

- Find 20 A on the bottom of the curve – 10 A breaker at 2X current is 20 A
- Follow the ampacity line up to the “time” tripping region of the curve.

The breaker will trip under a thermal overload in the area between where 20 A intersects the bottom curve line and the intersection of the top curve. The breaker is guaranteed to trip in this time bandwidth.

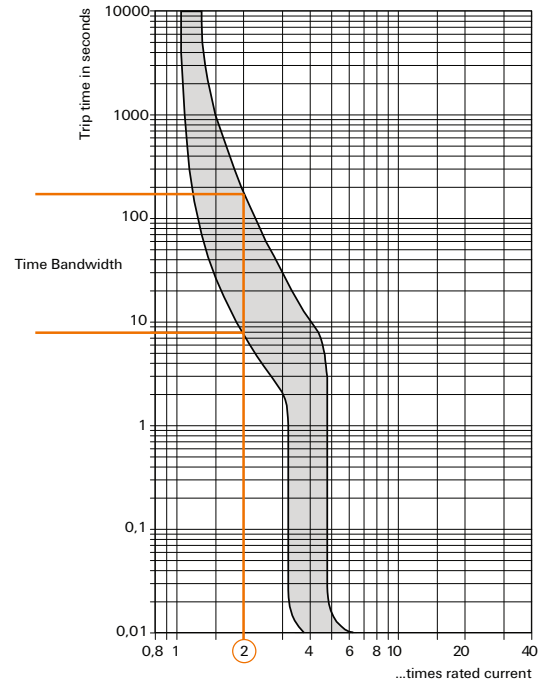

Example 2: Magnetic Tripping Characteristic

10 Amp B Curve Breaker Short Circuit at 70 Amps

To determine the time it takes for the breaker to trip with a 70 A short circuit:

- Find 70 A on the bottom of the curve – 10 A breaker at 7X current is 70 A
- Notice the “time” at the bottom left corner of the chart axis.

The breaker is guaranteed to trip no later than .01 seconds for any short circuit equal to 70 A.

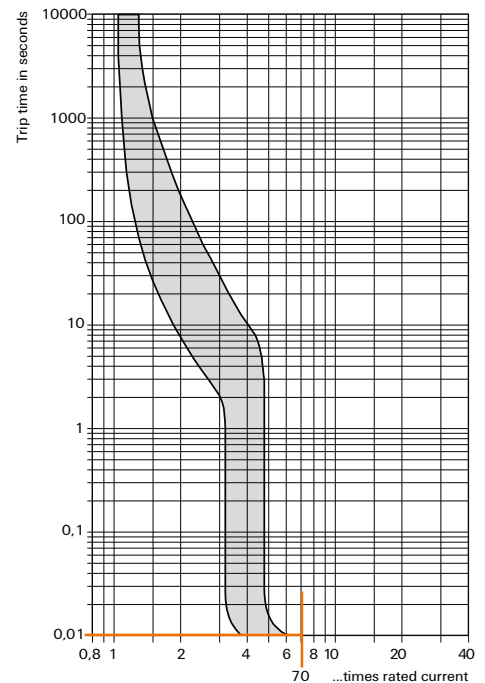

Ambient temperature derating

Maximum operating currents depending on ambient temperature

Rated current I_N (A)	Max. operating currents depending on ambient temperature T (A)										
	-35°C	-30°C	-25°C	-20°C	-15°C	-10°C	-5°C	0°C	+5°C	+10°C	+15°C
1	1.27	1.25	1.23	1.21	1.19	1.17	1.15	1.13	1.10	1.08	1.06
2	2.87	2.81	2.74	2.68	2.62	2.55	2.48	2.42	2.35	2.28	2.20
3	3.89	3.83	3.76	3.70	3.64	3.57	3.50	3.44	3.37	3.30	3.22
4	4.91	4.83	4.76	4.70	4.64	4.57	4.50	4.44	4.37	4.30	4.22
5	6.68	6.56	6.44	6.32	6.19	6.07	5.94	5.81	5.68	5.54	5.40
6	7.70	7.58	7.46	7.34	7.21	7.09	6.96	6.83	6.70	6.56	6.42
7	8.78	8.66	8.54	8.42	8.29	8.17	8.04	7.91	7.78	7.64	7.50
8	9.80	9.68	9.56	9.44	9.31	9.19	9.06	8.93	8.80	8.66	8.52
10	13.89	13.62	13.35	13.07	12.81	12.53	12.23	11.93	11.63	11.33	11.01
12	15.91	15.64	15.37	15.09	14.83	14.55	14.25	13.95	13.65	13.35	13.03
13	16.92	16.65	16.38	16.10	15.84	15.56	15.26	14.96	14.66	14.36	14.04
15	19.77	19.42	19.07	18.74	18.39	18.04	17.69	17.32	16.95	16.57	16.19
16	20.78	20.43	20.08	19.75	19.40	19.05	18.70	18.33	17.96	17.58	17.20
20	25.67	25.28	24.88	24.47	24.06	23.64	23.22	22.78	22.34	21.89	21.43
25	32.21	31.72	31.22	30.70	30.18	29.65	29.10	28.55	27.98	27.41	26.82
30	39.00	38.42	37.78	37.13	36.47	35.80	35.11	34.43	33.71	32.99	32.26
32	41.04	40.46	39.82	39.17	38.51	37.84	37.15	36.47	35.75	35.03	34.30
35	44.08	43.50	42.86	42.21	41.55	40.88	40.19	39.51	38.79	38.07	37.34
40	51.63	50.86	50.04	49.21	48.37	47.51	46.63	45.74	44.83	43.90	42.95
50	64.92	63.97	62.92	61.86	60.77	59.67	58.54	57.40	56.23	55.05	53.81
60	80.45	79.03	77.61	76.16	74.69	73.19	71.67	70.11	68.51	66.88	65.21
63	83.48	82.06	80.71	79.19	77.72	76.22	74.70	73.14	71.54	69.91	68.24

Rated current I_N (A)	Max. operating currents depending on ambient temperature T (A)										
	+20°C	+25°C	+30°C	+35°C	+40°C	+45°C	+50°C	+55°C	+60°C	+65°C	+70°C
1	1.05	1.02	1.00	0.97	0.94	0.91	0.89	0.86	0.83	0.80	0.77
2	2.12	2.04	2.00	1.90	1.82	1.74	1.65	1.56	1.47	1.36	1.25
3	3.14	3.06	3.00	2.92	2.84	2.76	2.67	2.58	2.49	2.38	2.27
4	4.14	4.06	4.00	3.92	3.84	3.76	3.67	3.58	3.49	3.38	3.27
5	5.25	5.12	5.00	4.82	4.66	4.50	4.34	4.17	3.99	3.81	3.62
6	6.27	6.14	6.00	5.84	5.68	5.52	5.36	5.19	5.01	4.83	4.64
7	7.35	7.22	7.00	6.92	6.76	6.60	6.44	6.27	6.09	5.91	5.72
8	8.37	8.24	8.00	7.94	7.78	7.62	7.46	7.29	7.11	6.93	6.74
10	10.67	10.34	10.00	9.63	9.24	8.85	8.45	8.01	7.55	7.06	6.55
12	12.69	12.36	12.00	11.65	11.26	10.60	10.47	10.03	9.57	9.08	8.57
13	13.70	13.37	13.00	12.66	12.27	11.61	11.48	11.04	10.58	10.09	9.58
15	15.79	15.39	15.00	14.54	14.10	13.65	13.19	12.70	12.20	11.69	11.64
16	16.80	16.40	16.00	15.55	15.11	14.66	14.20	13.71	13.21	12.70	12.65
20	20.96	20.47	20.00	19.47	18.95	18.42	17.87	17.30	16.71	16.10	15.47
25	26.22	25.61	25.00	24.33	23.67	23.00	22.28	21.56	20.80	20.02	19.21
30	31.50	30.73	30.00	29.13	28.30	27.44	26.56	25.65	24.71	23.74	22.73
32	33.54	32.77	32.00	31.17	30.34	29.48	28.69	27.69	26.75	25.78	24.77
35	36.58	35.81	35.00	34.21	33.38	32.52	31.64	30.73	29.79	28.82	27.81
40	41.98	40.99	40.00	38.93	37.85	36.75	35.61	34.43	33.21	31.95	30.63
50	52.56	51.28	50.00	47.82	46.24	44.81	43.33	41.81	40.23	38.58	35.77
60	63.50	61.75	60.00	57.08	55.16	53.18	51.13	49.00	46.78	44.47	40.47
63	66.53	64.78	63.00	60.11	58.19	56.21	54.16	52.03	49.81	47.50	43.50

ACDC Series D curve thermal magnetic tripping characteristics vs K curve

The K and UC Series D curve breakers are both designed for motor applications where ampacity rises quickly and momentarily during “start-up”. Both curves can “ride through” the momentary inrush of current and prevent nuisance tripping while providing protection to the circuit.

Both curves have almost identical tripping characteristics. The magnetic element tripping characteristics are identical between the two curves and the thermal element tripping characteristics have a slight variation.

Thermal Tripping Characteristics Comparison

Example:

10 Amp D Curve Breaker

Thermal Overload at 20 Amps

To determine the time it takes for the breaker to trip with a 20 A load:

- Find 20 A on the bottom of the curve – 10 A breaker at 2X current is 20 A
- Follow the ampacity line up to the “time” tripping region of the curve.

The breaker will trip under a thermal overload in the area between where 20 A intersects the bottom curve line (~7.5s) and the intersection of the top curve (~150s). The breaker is guaranteed to trip in this time bandwidth.

D Curve

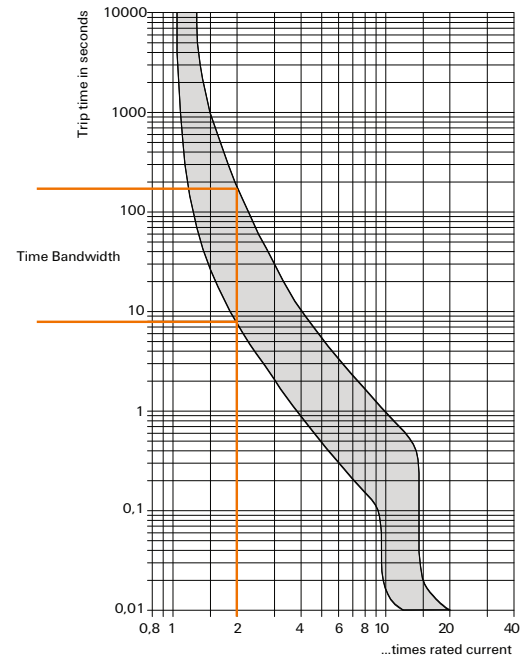

Similarly the K curve breaker will trip under a thermal overload between 6 and 350 seconds. The breaker is guaranteed to not trip before ~6 seconds and will not take longer than ~350 seconds to trip. The breaker may trip at any time in this time bandwidth.

K Curve

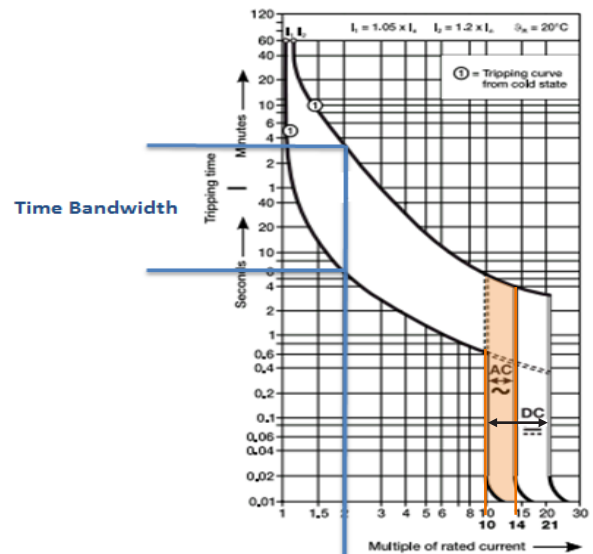

Short Circuit Tripping Characteristics Comparison

**Example:
10 Amp K Curve Breaker and UC Series 10 Amp
D Curve Breaker
Short Circuit at 100 Amps**

Both breakers have an element that will trip between 10 and 14 times rated current. Both breakers will trip under a short circuit before .01 seconds. And both breakers are guaranteed to trip no later than .01 seconds for any short circuit equal to 100 A or greater.

K and UC Series D Curve Summary

Thermal Element Minimum Tripping

The UC Series D curve MCB will interrupt an overload at 2X rated current in 7.5s or greater. The K curve MCB will interrupt an overload at 2X rated current in 6 seconds or greater. This additional time allows a circuit more time to "ride through" high inrush at start-up and prevent nuisance tripping.

Thermal Element Bandwidth

The K curve tripping bandwidth at 2X rated current is between 6 and 350 seconds. The UC Series D curve tripping bandwidth at 2X rated current is between 7.5 and 150 seconds. The differences between the bandwidths demonstrate calibration and quality control accuracy. The UC Series D curve breaker from Weidmuller has a much smaller tolerance bandwidth and requires a higher level of adjustment during manufacturing and quality control validation.

Magnetic Element

The magnetic element of the K curve and UC Series D curve MCBs are identical. Both breakers interrupt a short circuit at 10X the rated current (or greater) in no later than .01 seconds.

D Curve

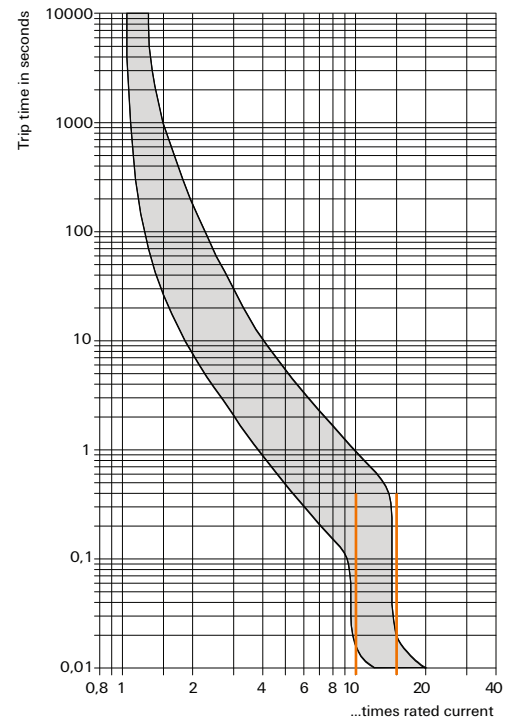

K Curve

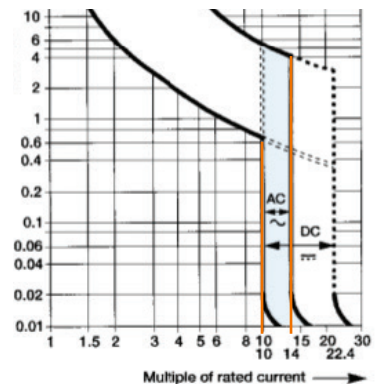

Weidmuller – Your Partner in Smart Industrial Connectivity

As experienced experts we support our customers and partners around the world with products, solutions and services in the industrial environment of power, signal and data. We are at home in their industries and markets and know the technological challenges of tomorrow. We are therefore continuously developing innovative, sustainable and useful solutions for their individual needs. Together we set standards in Industrial Connectivity.

Weidmuller, Inc

821 Southlake Blvd.

Richmond, Virginia 23236

Telephone: (800) 849-9343

Website: www.weidmuller.com

Email: customerservice@weidmuller.com

Weidmüller 